



LIGHTTECH

ILUMINACIÓN LED

- 📍 Av. Felipe Pardo y Aliaga 422,
San Isidro. Lima - Perú
- 📞 981 333 072
- ✉ ventas@lumicenter.com.pe
- 🌐 lumicenter.com.pe
- 📘 LumicenterPeru
- 📺 LumicenterPeru

Lumicenter

Desarrollamos proyectos integrales de iluminación en diferentes sectores e industrias a nivel nacional.

Nuestra marca **LIGHTTECH®** ofrece alta tecnología LED, eco-amigable y eficiente; con el portafolio de luminarias más completo del mercado.



Propuesta de Valor

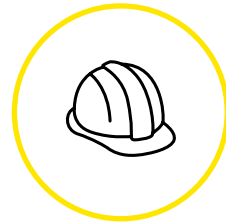

Asesoría personalizada de Expertos en Iluminación

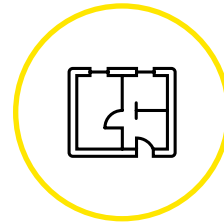

Desarrollo de Propuesta y Cálculos Lumínicos



Amplio Portafolio de Luminarias certificadas para MiVivienda Verde con Stock permanente



Financiamiento*, Garantía y Post Venta
*Sujeto a evaluación

Índice de Contenidos

04

Spots



06

Downlights

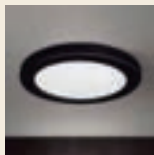

09

Paneles

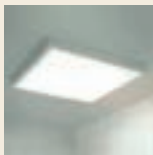

10

Lineales y Undercabinets



11

Proyectores y rieles

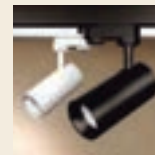

12

Línea Magnet



14

Lineales suspendidos



16

Apliques interiores

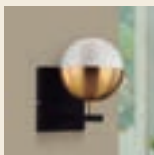

18

Plafones



20

Apliques exteriores

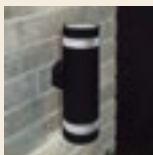

22

Luces Guía

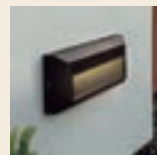

23

Estacas



24

Guirnaldas



Embutidos de piso

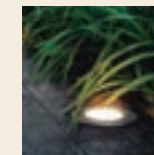

Postes

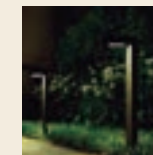

25

Luminarias herméticas

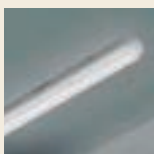

Campanas High Bay

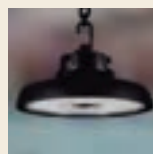

Urbanas



26

Reflectores



27

Emergencia y Salida



28

Luminarias Solares



29

Bombillería



32

Tiras Flexibles

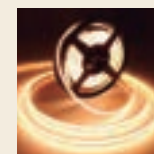

33

Luminarias Decorativas



Como leer la información de los productos

Dimensiones del producto

Ø: Diámetro L: Largo

W: Ancho H: Profundidad/Altura

Íconos de características principales

Ø:259.5 H:185.5 mm



DIM



IP65



Material del producto

Potencia en Watts

Temperatura de color de luz

Material Aluminio + Policarbonato
 100W 6000K 14000 Lm **cód. 146345**



2700K 3000K 4000K 6000K 6500K

Lúmenes

Código SKU

Iconografía



DIM

Dimerizable



IP65

Índice de protección contra agua y polvo



3 LUCES

Selector de color de luz por interruptor



SENSOR

Con sensor de movimiento



Dirección de haz de luz



36°

Ángulo de apertura



100LM/W

Eficiencia lumínica



SOLAR

Tecnología LED con panel solar



RGB

Luz LED RGB multicolor

PF >0.9

Alto factor de Potencia 0.9



Selector de color de luz por switch

50 MIL HORAS

Larga vida útil de 50 mil horas

Sectores que atendemos



Residencial

- Recepciones, pasadizos, escaleras y áreas recreativas
- Departamentos
- Estacionamientos y depósitos
- Fachadas, terrazas y jardines



Corporativo

- Coworkings
- Oficinas
- Centros empresariales

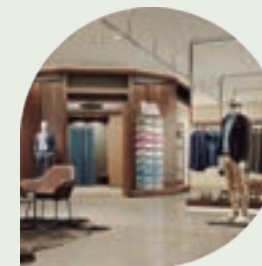

Comercial

- Restaurantes y cafeterías
- Tiendas por departamento
- Galerías y museos
- Hoteles
- Áreas de esparcimiento



Educativo

- Aulas y oficinas
- Bibliotecas y laboratorios
- Recepciones y halls
- Salones multiuso
- Fachadas y exteriores



Salud

- Recepciones
- Consultorios
- Salas de espera
- Laboratorios
- Fachadas y exteriores



Industrial

- Centros de distribución
- Naves industriales
- Fábricas
- Talleres de producción
- Almacenes



Deportivo

- Coliseos y estadios
- Canchas deportivas
- Clubes

Certificaciones internacionales



Conformidad Europea certifica el cumplimiento de requisitos de seguridad, sanidad y protección del medio ambiente exigidos por la Unión Europea.



Underwriters Laboratories certifica los estándares de calidad que reducen el riesgo de incendios y descargas eléctricas.

RoHS

ROHS garantiza la restricción de sustancias peligrosas (metales pesados) en aparatos electrónicos. Promueve el reciclaje, la reutilización y la recuperación de residuos.



Spots Empotrados

Spots No integrados (Usan foco LED)

Ø:82 H:35 mm | Perforación:72 mm



Material Aluminio
 1xGU10 MÁX 50W **cód. 147404**
 SEMI RECESADO

Ø:101 H:50 mm | Perforación:95 mm



Material Aluminio
 1xGU10 MÁX 50W ○ **cód. 147615**
 1xGU10 MÁX 50W ● **cód. 147885**
 RECESADOS

Ø:100 H:60 mm | Perforación:90 mm



Material Aluminio
 1xGU10 MÁX 50W ○ **cód. 144948**
 1xGU10 MÁX 50W ● **cód. 145558**
 RECESADOS

Ø:110 H:50 mm | Perforación:80 mm



Material Metal
 1xGU5.3 MÁX 20W ○ **cód. 148014**
 1xGU5.3 MÁX 20W ● **cód. 148015**

Ø:82 H:25 mm | Perforación:72 mm
 Ø:108 H:25 mm | Perforación:67 mm



Material Zamac
 1xGU10 MÁX 50W ○ **cód. 144615**
 1xGU10 MÁX 50W ● **cód. 144616**
 1xGU10 MÁX 50W ● **cód. 144618**

Ø:105 H:30 mm | Perforación:85 mm



Material Plástico
 1xGU10 ○ **cód. 147824**
 1xGU10 ● **cód. 147825**
 1xGU10 ● **cód. 147826**

Ø:110 H:29 mm | Perforación:80 mm

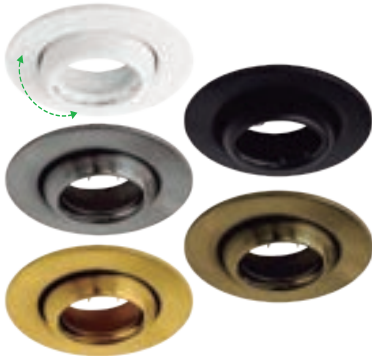

Material Metal
 1xGU10 MÁX 50W ○ **cód. 144601**
 1xGU10 MÁX 50W ● **cód. 144567**
 1xGU10 MÁX 50W ● **cód. 144603**
 1xGU10 MÁX 50W ● **cód. 144602**
 1xGU10 MÁX 50W ● **cód. 144952**

Ø:110 H:25 mm | Perforación:80 mm

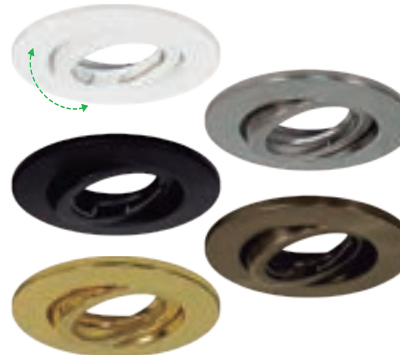

Material Metal
 1xGU10 MÁX 50W ○ **cód. 144604**
 1xGU10 MÁX 50W ● **cód. 144605**
 1xGU10 MÁX 50W ● **cód. 144606**
 1xGU10 MÁX 50W ● **cód. 144566**
 1xGU10 MÁX 50W ● **cód. 145276**

L:92 W:92 H:25 mm | Perforación:79x79 mm

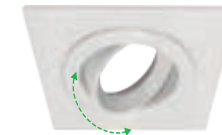

Material Aluminio
 1xGU10 MÁX 50W **cód. 144735**

Spot Hermético

Ø:84 H:42 mm | Perforación:68 mm

IP44



Material Aluminio
 1xGU10 MÁX 50W **cód. 144950**

Spots LED

Ø:60 H:30 mm | Perforación:50 mm



Material Policarbonato

3W 3000K 280 Lm **cód. 144621**
 3W 6000K 300 Lm **cód. 144642**

✓ IDEAL PARA MUEBLES

Ø:105 H:45 mm | Perforación:85 mm

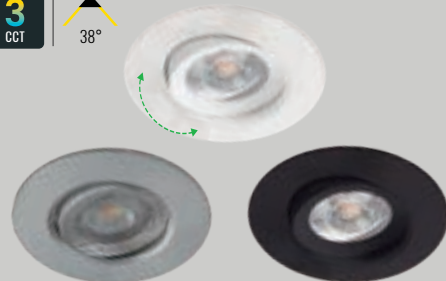

Material Policarbonato

5W COB 3000K-4000K-6000K 400 Lm ○ **cód. 147849**
 7W COB 3000K-4000K-6000K 580 Lm ○ **cód. 147850**
 7W COB 3000K-4000K-6000K 580 Lm ● **cód. 147851**
 7W COB 3000K-4000K-6000K 580 Lm ● **cód. 147911**
 10W COB 3000K-4000K-6000K 850 Lm ○ **cód. 147852**

✓ CON SWITCH SELECTOR DE LUZ CÁLIDA, NEUTRA O FRÍA

Ø:109 H:81 mm | Perforación:80-95 mm



Material Policarbonato

8W 3000K 500 Lm **cód. 146237**
 8W 6000K 520 Lm **cód. 146238**

✓ INCLUYE FOCO GU10

Ø:103 H:90 mm | Perforación:95 mm



Material Policarbonato

9W DIM 3000K 600 Lm ○ **cód. 146168**
 9W DIM 3000K 480 Lm ● **cód. 146169***
 *PRODUCTO A PEDIDO

✓ RECESADO

Ø:105 H:31 mm | Perforación:90 mm

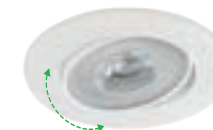

Material Policarbonato

9W 3000K 810 Lm **cód. 146080**

Ø:110 H:36 mm | Perforación:98 mm



Material Plástico

9W 3000K-4000K-6000K 720 Lm ● **cód. 148003**
 14W 3000K-4000K-6000K 1120 Lm ○ **cód. 148046**

✓ PARA CAJA OCTOGONAL

✓ CON SWITCH SELECTOR DE LUZ CÁLIDA, NEUTRA O FRÍA

Ø:110 H:36 mm | Perforación:98 mm



Material Metal

9W 3000K-4000K-6000K 720 Lm ○ **cód. 147846**
 9W 3000K-4000K-6000K 720 Lm ● **cód. 147845**
 9W 3000K-4000K-6000K 720 Lm ● **cód. 147910**
 14W 3000K-4000K-6000K 1120 Lm ○ **cód. 147848**
 14W 3000K-4000K-6000K 1120 Lm ● **cód. 147847**

✓ PARA CAJA OCTOGONAL

✓ CON SWITCH SELECTOR DE LUZ CÁLIDA, NEUTRA O FRÍA

L:105 W:105 H:44 mm | Perforación:72 mm



Material Policarbonato

7W COB 6000K 580 Lm **cód. 147507**

L:105 W:105 H:44 mm | Perforación:72x72 mm

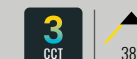

Material Policarbonato

7W COB 3000K-4000K-6000K 580 Lm **cód. 147853**

✓ CON SWITCH SELECTOR DE LUZ CÁLIDA, NEUTRA O FRÍA

Spots Adosados

Ø:80 H:125 mm



Material Policarbonato
1xGU10 ○ cód. 146505
1xGU10 ● cód. 146506

✓ LUZ DIRIGIBLE



L:80 W:80 H:125 mm



Material Policarbonato
1xGU10 ○ cód. 147200
1xGU10 ● cód. 147201

✓ LUZ DIRIGIBLE



USO CON FOCO LED

Ø Base:144 Ø:58 H:85 mm



Material Policarbonato
1xGU10 ● cód. 147823
1xGU10 ○ cód. 147822

✓ NO INCLUYE FOCO



Ø Base:110 Ø:60 H:75 mm



Material Policarbonato
7W 3000K 540 Lm ● cód. 146084
7W 6500K 560 Lm ● cód. 146085
7W 3000K 540 Lm ○ cód. 146082
7W 6500K 560 Lm ○ cód. 146083

52°



Ø Base:120 Ø:60 H:75 mm
L Base:250 W:59 H:90 mm



Material Policarbonato
2x7W 3000K 1100 Lm ● cód. 146486
3x7W 3000K 1575 Lm ○ cód. 146487

52°



Downlights Empotrados LED

Ø:221 H:26 mm | Perforación:187 mm
Ø:200 H:60 mm | Perforación:170 mm

PF >0.9



Material Policarbonato
18W 6000K 1620 Lm cód. 147778
25W 3000K 2050 Lm cód. 147613
25W 4000K 2150 Lm cód. 147566

Ø:170 H:40 mm | Perforación:150 mm
Ø:300 H:47 mm | Perforación:270 mm
Ø:225 H:40 mm | Perforación:200 mm

3 CCT

PF >0.9



Material Policarbonato
12W 3000K-4000K-6000K 1200 Lm cód. 147815
24W 3000K-4000K-6000K 2400 Lm cód. 147816
24W 3000K-4000K-6000K 2400 Lm cód. 147960

✓ CON SWITCH SELECTOR DE LUZ CÁLIDA, NEUTRA O FRÍA

Downlights Adosados o Empotrados LED

Ø Base:92 H:77 mm

3 CCT



Material Policarbonato
6W 3000K-4000K-6000K 600 Lm cód. 147864

✓ INSTALACIÓN ADOSADA CON CILINDRO

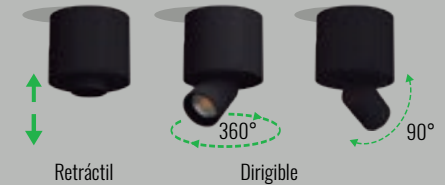

✓ INSTALACIÓN EMPOTRADA SIN CILINDRO



✓ CON SWITCH SELECTOR DE LUZ CÁLIDA, NEUTRA O FRÍA

Downlights Adosados o Empotrados LED

Ø:147 H:120 mm
 Ø:176 H:130 mm
 Ø:231 H:160 mm

3 CCT
PF >0.9
48 MIL HORAS
 60°

✓ INSTALACIÓN ADOSADA CON CILINDRO



✓ INSTALACIÓN EMPOTRADA SIN CILINDRO



Material Aluminio + Metal
 15W 3000K-4000K-6000K 1200 Lm **cód. 145908**
 20W 3000K-4000K-6000K 1640 Lm **cód. 145909**
 35W 3000K-4000K-6000K 2800 Lm **cód. 145910**

✓ CON SWITCH SELECTOR DE LUZ CÁLIDA, NEUTRA O FRÍA

Luminarias Adosados LED (Frameless)

2 TIPOS DE INSTALACIÓN

✓ EMPOTRADO CON CLIPS



✓ ADOSADO CON BASE DE FIJACIÓN



Ø:120 H:35 mm
 Ø:170 H:35 mm
 Ø:220 H:33.6 mm

L:169 W:169 H:32.6 mm

Material Policarbonato
 17W 3000K 1700 Lm **cód. 146958**
 17W 6500K 1700 Lm **cód. 146976**
 24W 4000K 2400 Lm **cód. 146945**
 24W 6500K 2400 Lm **cód. 146946**
 32W 3000K 2880 Lm **cód. 146440**
 32W 6500K 3200 Lm **cód. 147112**

Material Policarbonato
 24W 3000K 2160 Lm **cód. 146442**

Downlights Adosados LED

INSTALACIÓN
 ✓ ADOSADO CON CRUCETA

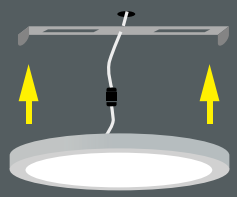

Ø:111 H:28 mm
 Ø:160 H:28 mm
 Ø:210 H:28 mm

Ø:174 H:35 mm

Ø:230 H:32 mm **PF >0.9**
 Ø:302 H:32 mm

Ø:121 H:32 mm
 Ø:178 H:32 mm
 Ø:230 H:32 mm
 Ø:302 H:32 mm

L:159 W:159 H:28 mm

Material Metal
 6W 3000K 470 Lm ○ **cód. 146493**
 6W 6000K 480 Lm ○ **cód. 146355**
 12W 6000K 960 Lm ● **cód. 147139**
 18W 3000K 1440 Lm ○ **cód. 146357**
 18W 6000K 1440 Lm ● **cód. 147140**

Material Polipropileno + Poliestireno
 12W 3000K 960 Lm **cód. 146672**
 ✓ MARCO DE POLIPROPILENO

Material Polipropileno + Poliestireno
 18W 4000K 1620 Lm **cód. 147769**
 24W 3000K 2040 Lm **cód. 147772**
 24W 4000K 2040 Lm **cód. 147771**

Material ABS + Polipropileno
 6W 30K-40K-60K 480 Lm **cód. 147893**
 12W 30K-40K-60K 960 Lm **cód. 147797**
 18W 30K-40K-60K 1620 Lm **cód. 147798**
 24W 30K-40K-60K 2040 Lm **cód. 147799**

Material Aluminio + ABS
 12W 6000K 960 Lm **cód. 146356**
 ✓ MARCO DE ALUMINIO

✓ CON SWITCH SELECTOR DE LUZ CÁLIDA, NEUTRA O FRÍA

Downlights Adosados LED con 2 Tipos de Instalación

2 TIPOS DE INSTALACIÓN

✓ EMPOTRADO CON CLIPS



✓ ADOSADO CON CRUCETA



Ø:298 H:17.8 mm



Material Polímero Termoplástico + Policarbonato

24W 6000K 1900 Lm **cód. 146497**

✓ MARCO DE POLÍMERO

Ø:126 H:17.8 mm
Ø:167 H:17.8 mm
Ø:220 H:17.8 mm
Ø:298 H:17.8 mm

3 CCT | PF >0.9



Material Policarbonato + Polipropileno

9W 3000K-4000K-6000K 600 Lm **cód. 147839**
12W 3000K-4000K-6000K 1030 Lm **cód. 147840**
18W 3000K-4000K-6000K 1600 Lm **cód. 147842**
24W 3000K-4000K-6000K 1800 Lm **cód. 147844**

✓ MARCO DE POLICARBONATO

✓ CON SWITCH SELECTOR DE LUZ CÁLIDA, NEUTRA O FRÍA

Ø:167 H:17 mm
Ø:220 H:17.8 mm

3 CCT | SENSOR | PF >0.9



Material Policarbonato + Polipropileno

12W 3000K-4000K-6000K 1030 Lm **cód. 147841**
18W 3000K-4000K-6000K 1600 Lm **cód. 147843**

✓ MARCO DE POLICARBONATO

✓ CON SWITCH SELECTOR DE LUZ CÁLIDA, NEUTRA O FRÍA

Ø:121 H:32 mm
Ø:230 H:32 mm

PF >0.9



Material ABS + Polipropileno

9W 3000K 810 Lm **cód. 147774**
9W 6500K 810 Lm **cód. 147775**
18W 3000K 1620 Lm **cód. 147776**
18W 6500K 1620 Lm **cód. 147777**

✓ MARCO DE ABS

Ø:126 H:17.8 mm
Ø:220 H:17.8 mm
Ø:298 H:17.8 mm

3 CCT | PF >0.9



Material Policarbonato + Polipropileno

9W 3000K-4000K-6000K 630 Lm **cód. 147867**
18W 3000K-4000K-6000K 1260 Lm **cód. 147868**
24W 3000K-4000K-6000K 1800 Lm **cód. 147870**

✓ MARCO DE POLICARBONATO

✓ CON SWITCH SELECTOR DE LUZ CÁLIDA, NEUTRA O FRÍA

Ø:220 H:17.8 mm

3 CCT | SENSOR | PF >0.9



Material Policarbonato + Polipropileno

18W 3000K-4000K-6000K 1530 Lm **cód. 147869**

✓ MARCO DE POLICARBONATO

✓ CON SWITCH SELECTOR DE LUZ CÁLIDA, NEUTRA O FRÍA



Paneles Empotrados LED

L:595 W:595 H:30 mm

PF >0.9 | **111LM/W** | **50 MIL HORAS** | **IP40**



Material Aluminio + Poliestireno
36W 4000K 4000 Lm **cód. 147121**
36W 6500K 4000 Lm **cód. 147120**

TECNOLOGÍA BACKLIT

L:595 W:595 H:30 mm

3 CCT | **PF** >0.9 | **120LM/W** | **50 MIL HORAS** | **IP40**



Material Aluminio + Poliestireno
36W 3000K-4000K-6000K 4320 Lm **cód. 147793**

TECNOLOGÍA BACKLIT

SWITCH SELECTOR DE LUZ CÁLIDA, NEUTRA O FRÍA

L:595 W:595 H:30 mm

3 CCT | **PF** >0.9



Material Aluminio + Poliestireno
48W 3000K-4000K-6000K 4320 Lm **cód. 147794**

TECNOLOGÍA BACKLIT

SWITCH SELECTOR DE LUZ CÁLIDA, NEUTRA O FRÍA

L:1195 W:295 H:30 mm

3 CCT | **PF** >0.9 | **111LM/W** | **50 MIL HORAS** | **IP40**



Material Aluminio + Poliestireno
36W 3000K-4000K-6000K 4000 Lm **cód. 147743**

TECNOLOGÍA BACKLIT

CON SWITCH SELECTOR DE LUZ CÁLIDA, NEUTRA O FRÍA

L:1195 W:295 H:30 mm

PF >0.9



Material Aluminio + Polipropileno
48W 4000K 4320 Lm **cód. 146241**
48W 6000K 4320 Lm **cód. 146737**

TECNOLOGÍA BACKLIT

L:595 W:595 H:90 mm

PF >0.9 | **108LM/W**

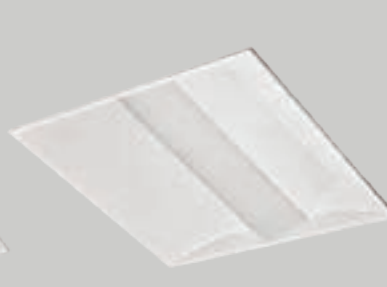

Material Acero + PMMA
35W 4000K 3800 Lm **cód. 145256**

L:595 W:595 H:30 mm

DIM | **PF** >0.9 | **100LM/W** | **50 MIL HORAS**

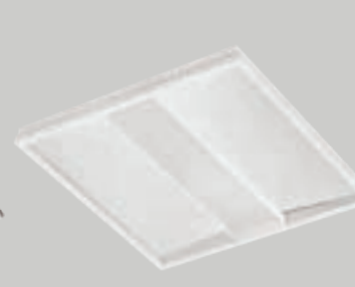

Material Aluminio
40W 4000K 4000 Lm **cód. 145394**

DIMERIZABLE DE 0/1-10V

UGR (ANTI DESLUMBRAMIENTO)

L:595 W:595 H:40 mm

105LM/W | **50 MIL HORAS** | **IP40**

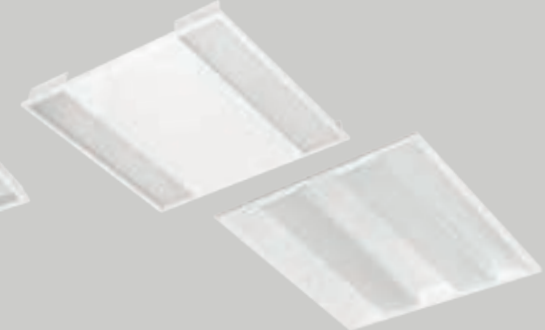

Material Metal + PMMA
40W 4000K 4200 Lm **cód. 123418**
40W 4000K 4200 Lm **cód. 123392**

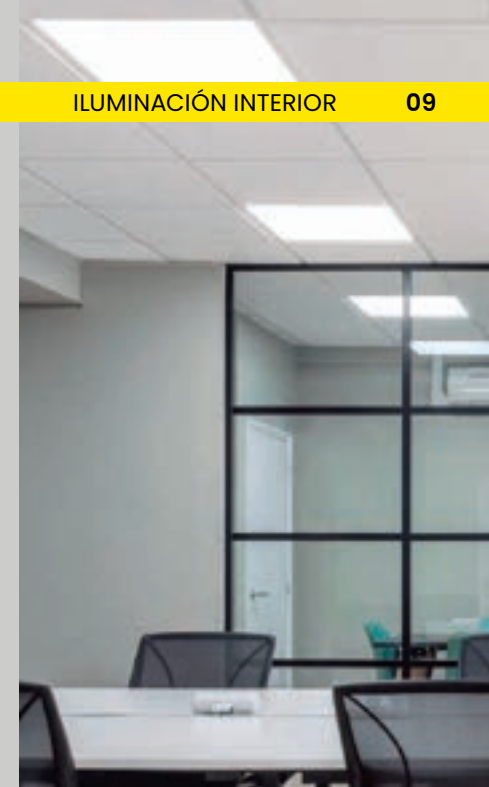

Accesorios

MARCO ADOSADO 60x60 CM Material: Aluminio **cód. 146911**

MARCO ADOSADO 30x120 CM Material: Aluminio **cód. 146878**

KIT DE SUSPENSIÓN **cód. 146236**

Paneles Adosados LED

L:600 W:600 H:38 mm

3
CCT | **PF**
>0.9

Material Aluminio + Polipropileno
48W 3000K-4000K-6000K 4320 Lm **cód. 147795**

✓ CON SWITCH SELECTOR DE LUZ CÁLIDA, NEUTRA O FRÍA

L:1200 W:300 H:38 mm

3
CCT | **PF**
>0.9

Material Aluminio + Polipropileno
48W 3000K-4000K-6000K 4320 Lm **cód. 147796**

✓ CON SWITCH SELECTOR DE LUZ CÁLIDA, NEUTRA O FRÍA

L:1200 W:150 H:36 mm

PF
>0.9

Material Aluminio + Policarbonato
48W 6000K 4000 Lm **cód. 146496**

Lineales Adosados LED

L:590 W:40 H:60 mm
L:1190 W:40 H:60 mm
PF
>0.9 | 100LM/W

LED INTEGRADO

Material Policarbonato

18W	6500K 1800 Lm	○	cód. 147563
18W	6500K 1800 Lm	●	cód. 147878
36W	6500K 3600 Lm	○	cód. 147564
36W	6500K 3600 Lm	●	cód. 147565

L:1190 W:60 H:36 mm

PF
>0.9

LED INTEGRADO

Material Policarbonato
36W 3000K-4000K-6000K 3240 Lm **cód. 147938**

✓ CON SWITCH SELECTOR DE LUZ CÁLIDA, NEUTRA O FRÍA

L:600 W:24 H:74 mm
L:1200 W:24 H:75 mm
PF
>0.9 | 100LM/W

LED INTEGRADO

Material Policarbonato

SLIM 18W	6500K 1800 Lm	○	cód. 147542
SLIM 18W	6500K 1800 Lm	●	cód. 147916
SLIM 36W	6500K 3600 Lm	○	cód. 147543
SLIM 36W	6500K 3600 Lm	●	cód. 147917

LIGHTTECH

Undercabinet Adosado LED

L:568 W:36 H:22 mm

3 LUCES

Material Policarbonato
9W 3000K-4000K-6500K 720 Lm **cód. 147178**

✓ OPCIÓN PARA UNIR EN LÍNEA



✓ INCLUYE ENCHUFE PLANO

✓ 3 PASOS PARA SELECCIÓN DE LUZ CÁLIDA, FRÍA O NEUTRA





Proyectores LED para Riel

Ø:60 H:125 mm  **PF >0.9** 

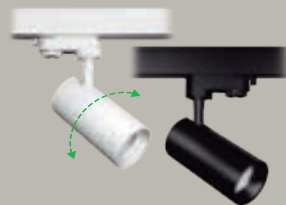

Material Poliamida + Policarbonato
 10W COB 3000K 1040 Lm ○ **cód. 147537**
 10W COB 3000K 1040 Lm ● **cód. 147539**

Ø:80 H:185 mm  **PF >0.9** 



Material Poliamida + Policarbonato
 20W COB 3000K 2100 Lm ○ **cód. 147538**
 20W COB 3000K 2100 Lm ● **cód. 147540**
 20W COB 4000K 2250 Lm ● **cód. 147541**

Ø:80 H:125 mm   **PF >0.9** 



Material Aluminio + Policarbonato
 30W 3000K-4000K-6000K 3000 Lm ○ **cód. 148002**
 30W 3000K-4000K-6000K 3000 Lm ● **cód. 147821**

 **SWITCH SELECTOR DE LUZ CÁLIDA, NEUTRA O FRÍA**

Ø:69 H:142 mm 

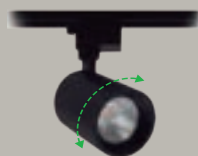

Material Aluminio
 10W 3000K 900 Lm ● **cód. 146390**

Ø:59 H:154 mm 



Material Aluminio + Policarbonato
 1xGU10 3000K 800 Lm ○ **cód. 147494**
 1xGU10 3000K 800 Lm ● **cód. 147495**
 1xGU10 3000K 800 Lm ● **cód. 147496**

 **INCLUYEN FOCO GU10 LED 8W**

Ø:56 H:275 mm 



Material Aluminio
 10W 3000K 800 Lm **cód. 145041**

Rieles adosados para Proyectores

1 METRO



2 METROS



Material Aluminio
 1 METRO ○ **cód. 148010**
 1 METRO ● **cód. 146884**
 2 METROS ○ **cód. 146882**
 2 METROS ● **cód. 148009**

 **RIELES DE UNA LÍNEA (1L+N)**



Línea Magnet LED

Lineales

L:300 W:22 H:43 mm 

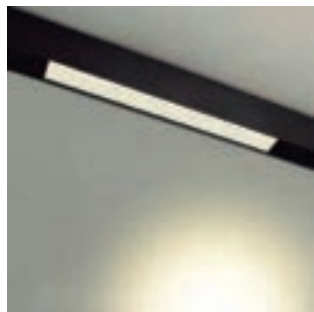

Material Aluminio + ABS
12W 3000K 300 Lm **cód.147593**

L:600 W:22 H:43 mm 



Material Aluminio + ABS
24W 3000K 600 Lm **cód.147594**

Lineal

L:330 W:22 H:44 mm 



Material Aluminio
18W 3000K 990 Lm **cód.147953**

Lineal Dirigible

L:230 W:22 H:85 mm 

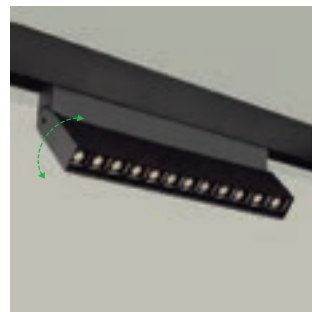

Material Aluminio
12W 3000K 350 Lm **cód.147595**

Proyector

Ø:70 L:116 mm 



Material Aluminio
20W 3000K 480 Lm **cód.147596**

Colgantes

Ø:50 L:150 mm | Altura hasta 1400 mm 
Ø:50 L:300 mm | Altura hasta 1500 mm

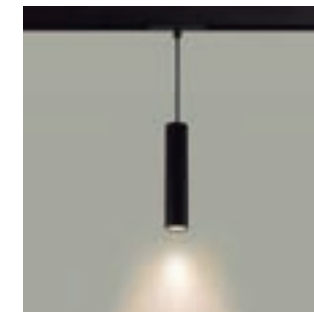

Material Aluminio
6W 3000K 180 Lm **cód.147597**
12W 3000K 790 Lm **cód.147952**

Rieles Magnet Adosados

1 metro



Material Aluminio
cód. 147604

2 metros



Material Aluminio
cód. 147605

Conectores Magnet

Lineal

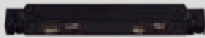

Material Policarbonato
cód. 147598

Flexible



Material Policarbonato
cód. 147599

Ángulos Magnet

De techo



Material Aluminio
cód. 147600

De techo/pared



Material Aluminio
cód. 147601

Drivers Magnet

L:255 W:23 H:44 mm



Potencia Máx. 100W
Material Policarbonato
Entrada 100-240V/50-60Hz
Salida 48VDC
Corriente Máx. 2.1A
Vida útil 30,000 horas
cód. 147602

L:255 W:23 H:44 mm



Potencia Máx. 200W
Material Policarbonato
Entrada 100-240V/50-60Hz
Salida 48VDC
Corriente Máx. 4.2A
Vida útil 30,000 horas
cód. 147603

Accesorio de Suspensión



Material Metal
cód. 147954

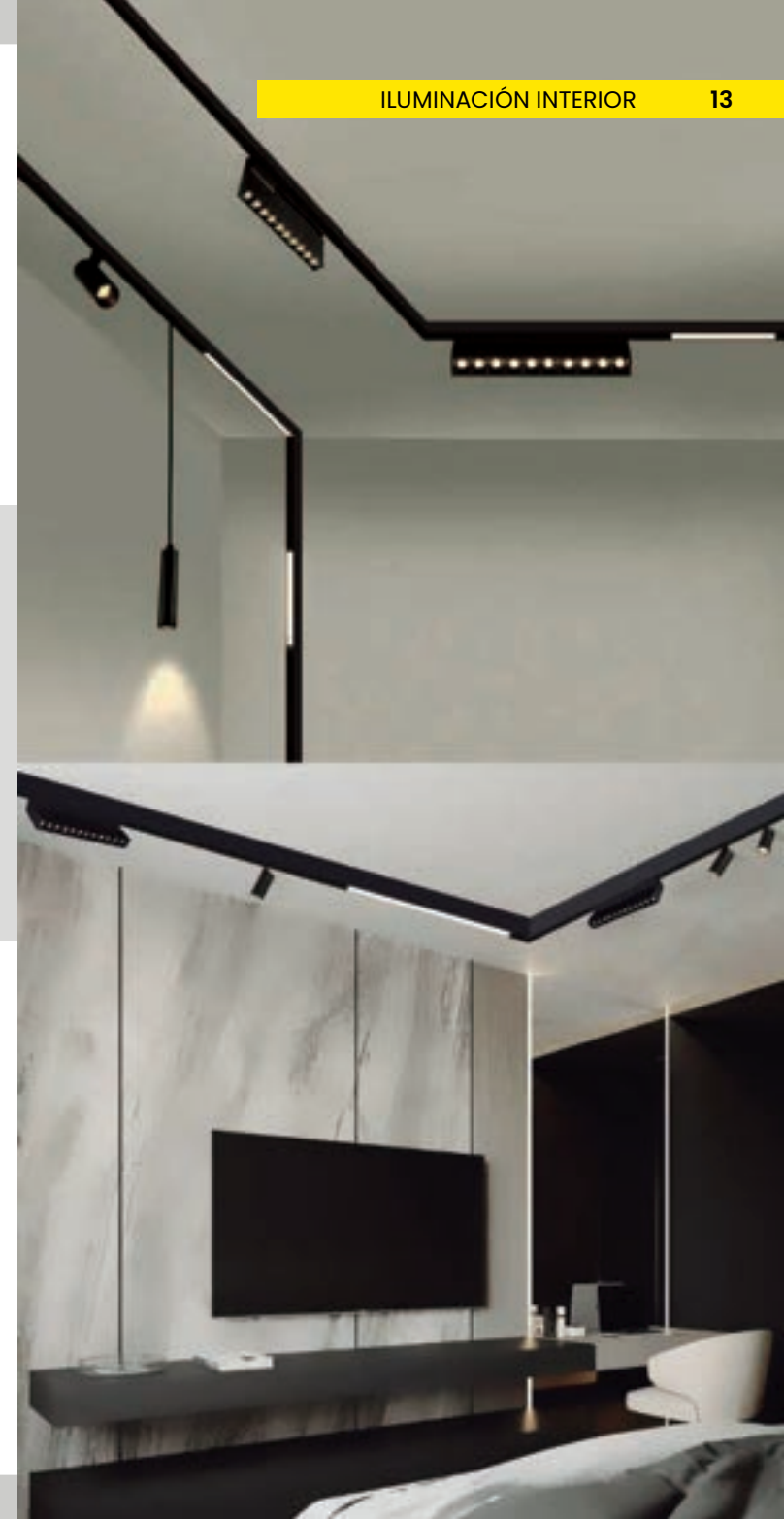

Lineal Block LED

Adosada o Suspendida & Conectores

L:1131 W:50 H:75 mm | Altura regulable hasta 1400 mm



Material Aluminio + Policarbonato

32W 3000K-4000K-6000K 2880 Lm cód. 145853

✓ LUZ DIRECTA. INSTALACIÓN ADOSADA O Suspendida

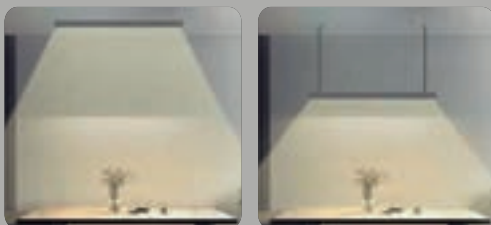

✓ DIFUSOR CON UGR (ANTI DESLUMBRAMIENTO)



✓ CON SWITCH SELECTOR DE LUZ CÁLIDA, NEUTRA O FRÍA

Conectores para crear figuras según el espacio

EN I
cód. 145856



ANGULAR
cód. 145855



ANGULAR 3
cód. 145859



ANGULAR 4
cód. 145860



Lineal Block LED

L:1130 W:50 H:76 mm | Altura regulable hasta 1400 mm

3 CCT | **PF >0.9** | **50 MIL HORAS** | 100LM/W | 60°

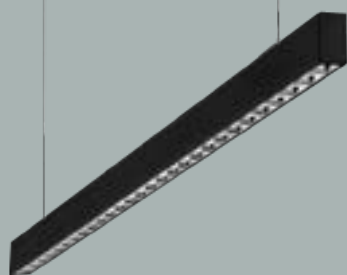

Material Aluminio
32W 3000K-4000K-6000K 3200 Lm cód. 147990

✓ CON SWITCH SELECTOR DE LUZ CÁLIDA, NEUTRA O FRÍA

Lineales Suspendingos LED

L:1217 W:64 H:75 mm | Altura regulable hasta 1400 mm

PF >0.9 | 100LM/W | **50 MIL HORAS** | 110°

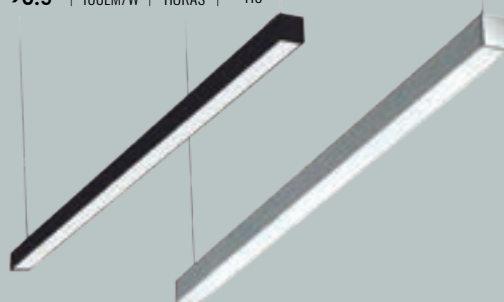

Material Aluminio
40W 4000K 4000 Lm ● cód. 145705
40W 4000K 4000 Lm ● cód. 145302

✓ CON DIFUSOR

✓ INSTALACIÓN ADOSADA O SUSPENDIDA (EL KIT DE SUSPENSIÓN ESTÁ INCLUIDO)



✓ OPCIÓN PARA UNIR EN LÍNEA USANDO UN CONECTOR INVISIBLE

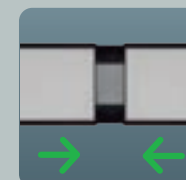

CONECTOR EN "I" cód. 145421

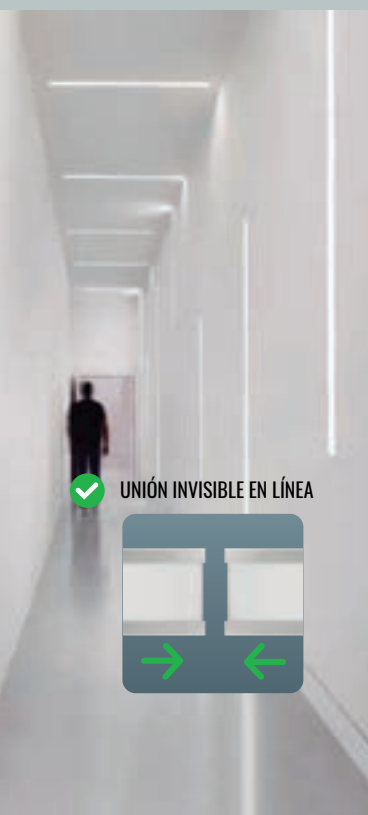

✓ UNIÓN INVISIBLE EN LÍNEA



Lineal Empotrado LED

L:1231 W:84 H:51 mm | Perforación: 1215x68 mm

PF >0.9 | 100LM/W | **50 MIL HORAS** | 100°



Material Aluminio
40W 4000K 4000 Lm cód. 145270

Lineal Recesado LED

L:379 W:61 H:48 mm | Perforación: 370x50 mm

30°



Material Aluminio + Plástico
20W 3000K 1060 Lm cód. 147202



✓ LENTES ÓPTICAS CON ÁNGULO DE APERTURA DE LUZ DE 30°

Bañador de Pared LED

L:500 W:43 H:18 mm | Perforación: 502x38 mm

PF >0.9 | **50 MIL HORAS** | 30°



Material Aluminio + Policarbonato
15W 3000K 1200 Lm cód. 145048

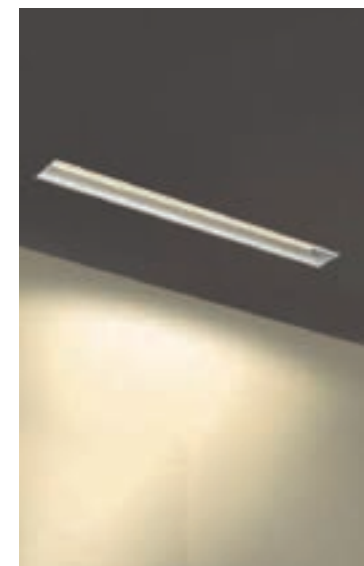

Apliques de Interior LED

L:80 W:260 H:200 mm



Material Aluminio + Metal + Acrílico

3W 3000K 184 Lm cód. 147371
 3W 3000K 184 Lm cód. 147372

SWITCH ON/OFF

L:63 W:145 H:150 mm



Material Metal + Acrílico

7W 3000K 490 Lm cód. 147755
 7W 3000K 490 Lm cód. 147533

SWITCH ON/OFF

L:60 W:110 H:150 mm



Material Metal + Aluminio

2W 3000K 140 Lm cód. 147754
 2W 3000K 140 Lm cód. 147534

SWITCH ON/OFF

L:120 W:141 H:120 mm
 L:288 W:141 H:120 mm
 L:308 W:141 H:120 mm

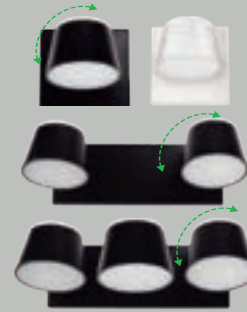

Material Plástico

7W 3000K 420 Lm cód. 146739
 7W 3000K 420 Lm cód. 146740
 2x7W 3000K 840 Lm cód. 146741
 3x3W 3000K 1260 Lm cód. 146742

L:250 W:100 H:95 mm
 L:435 W:100 H:95 mm



Material Aluminio + Metal

6W 3000K 450 Lm cód. 145170
 12W 3000K 900 Lm cód. 145171

L:280 W:80 H:85 mm



Material Metal + Acrílico

10W 3000K 549 Lm cód. 147375

L:180 W:90 H:25 mm



Material Metal + Aluminio + Vidrio

10W 3000K 968 Lm cód. 147373

L:285 W:90 H:123 mm

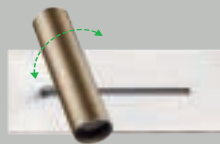

DETALLE DE LUZ FRONTAL

Material Aluminio

8W 3000K 480 Lm cód. 145658

L:600 W:50 H:100 mm



Material Aluminio + Metal + Acrílico

30W 3000K 2550 Lm cód. 145173

L:900 W:60 H:130 mm



Material Policarbonato

20W 3000K 1454 Lm cód. 147374

L:604 W:104 H:60 mm



LUZ INDIRECTA

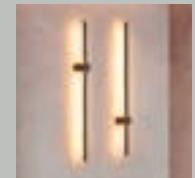

INSTALACIÓN
BASE FIJA

INSTALACIÓN
BASE GIRATORIA 360°

Material Aluminio + Policarbonato

12W 3000K 775 Lm | FIJA cód. 146983
 12W 3000K 775 Lm | GIRATORIA cód. 148044

Apliques de Interior No Integrados

L Base:149 W:204 H:217 mm



Material Metal + Vidrio
1xE27 MÁX 25W **cód. 147475**

Ø Base:100 L:185 W:180 H:430 mm



Material Metal + Vidrio
1xE27 MÁX 40W **cód. 146524**

Ø Base:100 L:120 W:230 H:230 mm



Material Metal + Vidrio
1xE27 MÁX 40W **cód. 146523**

Ø Base:120 L:130 W:200 H:250 mm



Material Metal + Vidrio
1xE27 MÁX 40W **cód. 147091**

Ø Base:120 W:210 H:316 mm



Material Metal + Ratán
1xE27 MÁX 40W **cód. 147473**
✓ SWITCH ON/OFF

Ø Base:86 W:120 mm
L:300 W:86 H:100 mm

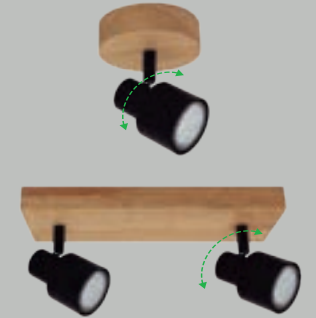

Material Metal + Madera
1xGU10 MÁX 50W **cód. 147367**
2xGU10 MÁX 50W **cód. 147368**

Ø Base:110 L:132 H:147 mm

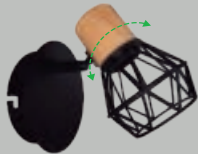

Material Metal
1xE27 MÁX 60W **cód. 147443**

Ø Base:110 L:350 H:170 mm

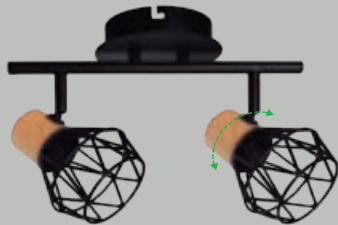

Material Metal
2xE27 MÁX 60W **cód. 147444**

Ø Base:110 W:285 H:237 mm



Material Metal
1xE27 MÁX 60W **cód. 147445**

Ø:110 W:132 H:110 mm

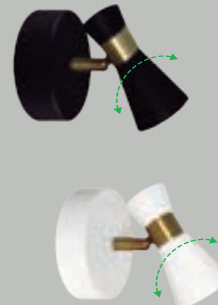

Material Metal
1xGU10 MÁX 35W ● **cód. 147437**
1xGU10 MÁX 35W ○ **cód. 147438**

Ø Base:110 L:327 H:137 mm

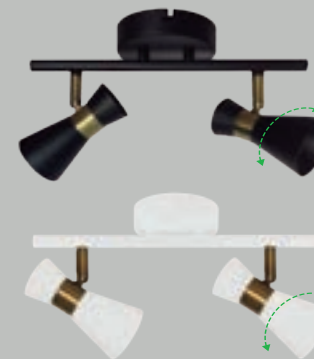

Material Metal
2xGU10 MÁX 35W ● **cód. 147439**
2xGU10 MÁX 35W ○ **cód. 147440**

Ø Base:110 W:106 H:230 mm



Material Metal
2xGU10 MÁX 35W **cód. 147442**

Plafones LED

Ø:125 H:45 mm
Ø:200 H:50 mm



Material Metal + ABS

12W 6000K 1080 Lm **cód. 145588**
24W 6000K 2160 Lm **cód. 145589**

Ø:380 H:60 mm



Material Plástico

40W 6000K 2800 Lm | SIN MARCO **cód. 147075**
40W 3000K 2800 Lm | CON MARCO **cód. 147078**
40W 6000K 2800 Lm | CON MARCO **cód. 147077**

Ø:380 H:60 mm



Material Plástico

40W 3000K 2800 Lm ● **cód. 147082**
40W 6000K 2800 Lm ● **cód. 147081**
40W 3000K 2800 Lm ● **cód. 147080**
40W 6000K 2800 Lm ● **cód. 147079**

Ø:400 H:60 mm
Ø:400 H:96 mm



Material Metal + Aluminio + Acrílico

36W 3000K 2160 Lm ● **cód. 147083**
45W 3000K 2279 Lm ● **cód. 147924**

Ø:400 H:90 mm



Material Acero + Policarbonato

37W 3000K 2590 Lm ● **cód. 147341**
37W 3000K 2590 Lm ● **cód. 147342**

Ø:455 H:150 mm



Material ABS + Acero + Metal

32W 3000K 2720 Lm ○ **cód. 146383**
32W 3000K 2720 Lm ● **cód. 146384**

Ø:455 H:170 mm



Material ABS + Acrílico + Metal

36W 3000K 2520 Lm ● **cód. 146955**
36W 3000K 2520 Lm ○ **cód. 146953**

Ø:805 H:160 mm
Ø:805 H:175 mm

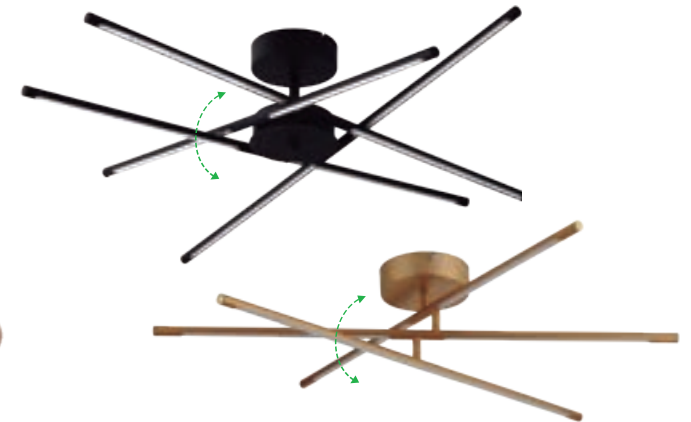

Material Metal + Acrílico

40W 3000K 3200 Lm ● **cód. 147526**
32W 3000K 2560 Lm ● **cód. 147525**

Plafones Ventiladores Smart

Ø:550 H:220 mm



Material Poliestireno + Acrílico

36W 3000K-4000K-6500K 3300 Lm **cód. 147751**

✓ VENTILADOR DE 6 VELOCIDADES

✓ CONTROL POR APP APPLIANCE SMART

Ø:500 H:140 mm



Material Metal + Acrílico

30W 3000K-4000K-6500K 2500 Lm **cód. 147752**

30W 3000K-4000K-6500K 2500 Lm **cód. 147753**

✓ VENTILADOR DE 6 VELOCIDADES

✓ CONTROL POR APP APPLIANCE SMART

✓ SWITCH SELECTOR DE LUZ CÁLIDA, NEUTRA O FRÍA

Plafones Herméticos LED IP65

Ø:220 H:66 mm



Material Aluminio + Policarbonato

20W 6000K 1800 Lm **cód. 145367**

Ø:165 H:58 mm



Material Aluminio + Policarbonato

15W 3000K 1400 Lm **cód. 147836**

15W 6000K 1480 Lm **cód. 147782**

20W 6000K 1800 Lm **cód. 147783**

Ø:280 H:50 mm



SELECCIÓN DE POTENCIAS Y TEMPERATURAS

13W	18W
██████████	
3000K	4000K 6000K
██████████	

Material Policarbonato

13W-18W 3000K-4000K-6000K 1500-2100 Lm **cód. 147989**

✓ SWITCH SELECTOR DE LUZ CÁLIDA, NEUTRA O FRÍA

Ø:226 H:72 mm



Material Aluminio + Policarbonato

20W 3000K-4000K-6000K 1800 Lm **cód. 147810**

20W 3000K-4000K-6000K 1800 Lm **cód. 147872**

20W 3000K-4000K-6000K 1800 Lm **cód. 147811**

✓ SWITCH SELECTOR DE LUZ CÁLIDA, NEUTRA O FRÍA

Ø:300 H:78 mm



Material Aluminio + Policarbonato

30W 3000K-4000K-6000K 2700 Lm **cód. 148042**

30W 3000K-4000K-6000K 2700 Lm **cód. 147812**

✓ SWITCH SELECTOR DE LUZ CÁLIDA, NEUTRA O FRÍA



Apliques de Exterior

L:210 W:48 H:80 mm



L:80 W:75 H:63 mm
L:144 W:80 H:63 mm



L:180 Ø:90 H:105 mm
L:183 Ø:95 H:108 mm



L:271 W:76 H:146 mm



L:212 W:56 H:113 mm
L:270 W:71 H:146 mm



Material Acrílico + Polipropileno
8W 3000K 800 Lm **cód. 147483**

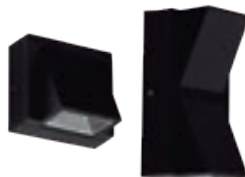

Material Policarbonato
6W 3000K 600 Lm **cód. 147492**
12W 3000K 1200 Lm **cód. 147493**



Material Aluminio
10W COB 3000K 400 Lm **cód. 147115**
10W 3000K 400 Lm **cód. 147116**



Material Policarbonato
20W 3000K 1750 Lm **cód. 144806**
20W 6000K 1800 Lm **cód. 144807**



Material Policarbonato
15W **PF 0.5** 3000K 1350 Lm ○ **cód. 147454**
15W **PF 0.9** 3000K 1350 Lm ○ **cód. 147837**
15W **PF 0.9** 6000K 1350 Lm ○ **cód. 147784**
15W **PF 0.9** 3000K 1350 Lm ● **cód. 147951**
20W **PF 0.9** 3000K 1800 Lm ○ **cód. 147785**
20W **PF 0.9** 6000K 1800 Lm ○ **cód. 147786**
20W **PF 0.9** 6000K 1800 Lm ● **cód. 147909**

Apliques LED con ángulos de apertura graduables

L:100 W:100 H:100 mm



L:120 W:120 H:29 mm



✓ PESTAÑAS CON ÁNGULOS GRADUABLES HASTA 92°



Material Aluminio
6W **PF 0.5** 3000K 360 Lm ○ **cód. 147740**
6W **PF 0.9** 3000K 360 Lm ● **cód. 147919**



Material ABS
4W 3000K 180 Lm ○ **cód. 147756**
4W 3000K 180 Lm ● **cód. 147741**

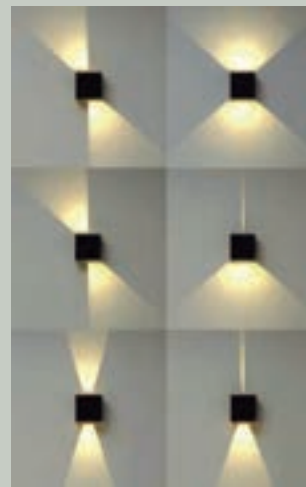

Ø:120 H:47 mm
Ø:222 H:47 mm



✓ LUZ INDIRECTA
✓ USO INTERIOR Y EXTERIOR

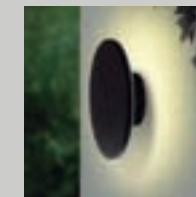

Material Policarbonato
9W 3000K-4000K-6000K 900 Lm ○ **cód. 147804**
9W 3000K-4000K-6000K 900 Lm ● **cód. 147490**
15W 3000K-4000K-6000K 1500 Lm ○ **cód. 147805**
15W 3000K-4000K-6000K 1500 Lm ● **cód. 147491**

✓ CON SWITCH SELECTOR DE LUZ CÁLIDA, NEUTRA O FRÍA

L:230 W:90 H:100 mm
L:250 W:105 H:110 mm



Material Policarbonato / Aluminio + Vidrio
12W 3000K 1000 Lm **cód. 147113**
20W 3000K 580 Lm **cód. 145032**

L:300 W:150 H:86 mm



Material Policarbonato
20W 6000K 1500 Lm **cód. 147300**

L:270 W:140 H:94 mm



Material Policarbonato
30W 6000K 2700 Lm ○ **cód. 147831**
30W 3000K 2700 Lm ● **cód. 147829**
30W 6000K 2700 Lm ● **cód. 147830**

L:150 W:72 H:95 mm



Material Policarbonato
2xGU10 **cód. 146504**

✓ NO INCLUYE FOCO

L:250 Ø:90 H:148 mm



Material Aluminio + Vidrio
1xE27 MÁX 35W **cód. 147114**

✓ NO INCLUYE FOCO

L:205 W:120 H:100 mm



Material Policarbonato + Vidrio
1xE27 MÁX 50W ○ **cód. 145761**
1xE27 MÁX 50W ● **cód. 145760**

✓ NO INCLUYEN FOCO

L:240 Ø:78 H:99 mm



Material Policarbonato
18W 30K-40K-60K 1600 Lm **cód. 147865**

Ø:170 H:100 mm



Material Policarbonato
15W 30K-40K-60K 1000 Lm **cód. 148019**

L:320 W:130 H:100 mm



Material Policarbonato
24W 30K-40K-60K 1800 Lm **cód. 148020**

L:268 W:132 H:87 mm



Material Policarbonato
20W 30K-40K-60K 1800 Lm **cód. 147832**

L:160 W:160 H:11 mm



Material Policarbonato + Polipropileno
15W 30K-40K-60K 1200 Lm **cód. 148018**

✓ CON SWITCH SELECTOR DE LUZ CÁLIDA, NEUTRA O FRÍA



Luces Guía Empotradas LED

L:230 W:80 H: 57 mm

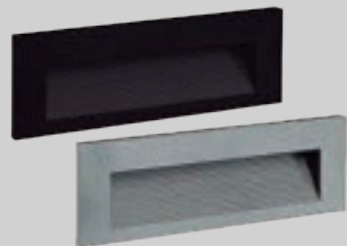

Material Policarbonato

6W 30K-40K-60K 300 Lm ● cód. 147817
6W 30K-40K-60K 300 Lm ● cód. 147818

✓ SWITCH SELECTOR DE LUZ CÁLIDA, NEUTRA O FRÍA

L:123 W:53 H:61 mm



Material Aluminio + Policarbonato

2W 3000K 90 Lm cód. 145638

LIGHTTECH

Luces Guía Adosadas LED

Ø:110 H:15 mm



Material Policarbonato

3W 3000K 200 Lm ● cód. 147833
3W 3000K 200 Lm ○ cód. 147834



L:84 W:84 H:43 mm



Material Aluminio

3W 3000K 90 Lm cód. 145034

L:90 W:90 H:71 mm



Material Aluminio

3W 3000K 135 Lm cód. 145639

L:84 W:84 H:43 mm



Material Aluminio

3W 3000K 60 Lm cód. 147358

L:80 W:80 H:61 mm



Material Aluminio + Policarbonato

2W 3000K 90 Lm cód. 145324

L:230 W:80 H:25 mm



Material Policarbonato

6W 30K-40K-60K 300 Lm ● cód. 147819
6W 30K-40K-60K 300 Lm ● cód. 147820

✓ SWITCH SELECTOR DE LUZ CÁLIDA, NEUTRA O FRÍA

L:110 W:90 H:13 mm



Material Policarbonato

4W 30K-40K-60K 250 Lm cód. 147835

✓ SWITCH SELECTOR DE LUZ CÁLIDA, NEUTRA O FRÍA

Estacas de Jardín

Estaca:155 Ø:92 mm
IP65

✓ ADOSADA

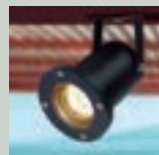

✓ INCRUSTADA

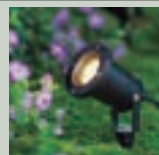

Material Aluminio
1xGU10 MÁX 50W **cód. 16780**

Estaca:190 Ø:76 mm
IP44



Material ABS
1xE27 MÁX 100W **cód. 147969**

Estaca:100 L:100 W:90 mm
IP65 120°

✓ ADOSADA EN PARED



✓ INCRUSTADA

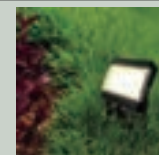

Material ABS
8W 3000K 525 Lm **cód. 146715**

L:120 W:145 Ø:56 mm
IP65 38°

✓ USO EN PARED



✓ USO EN TECHO

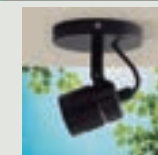

Material ABS
6W 3000K 480 Lm **cód. 145355**

Estaca:105 Ø:55 mm
IP65 38°



Material Policarbonato
6W 3000K 540 Lm **cód. 146716**

Estaca:170 Ø:74 mm
IP65 38°



Material Policarbonato
7W 3000K 580 Lm **cód. 144737**

Estaca:178 Ø:57 mm
IP65 38°



Material Aluminio + ABS
10W COB 3000K 800 Lm **cód. 147544**

Estaca:178 Ø:57 mm
IP65 RGB DIM 38°



✓ CONTROL REMOTO



Material Aluminio + ABS
10W RGB 600 Lm **cód. 147545**

L:738 mm (Altura regulable)
IP65 105.9°



✓ PUNTA PARA INCRUSTAR

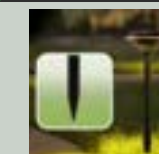

✓ BASE PARA SOBREPONER



Material Policarbonato
12W 3000K 1200 Lm **cód. 147968**



Guirnalda LED

Largo:10 metros



Material PVC + Cable de cobre
20xE27 MÁX 20W **cód. 147618**

- 10 METROS PARA 20 FOCOS (NO INCLUIDOS)
- CONEXIÓN DIRECTA CON ENCHUFE PLANO
- UNE HASTA 5 GUIRNALDAS (MÁX 50 METROS)



Packs x 20 Focos LED ST14 E27



Material	Policarbonato	
1W Clear	3000K 45 Lm	cód. 147857
1W Ambar	3000K 45 Lm	cód. 147856

Postes

Ø:135 H:570 mm



Material Aluminio
1xE27 MÁX 35W **cód. 147119**

NO INCLUYE FOCO

L:83 H:615 mm



Material ABS + Vidrio
10W 3000K 600 Lm **cód. 147546**



Embutidos de Piso

Ø:120 H:70 mm
Perforación:98 mm



Ø:80 H:74 mm
Perforación:73 mm



Ø:100 H:145 mm
Perforación:95 mm



Material Aluminio
3W 3000K 240 Lm **cód. 145758**

Material Aluminio
5W 3000K 275 Lm **cód. 147180**

Material Aluminio
7W COB 3000K 560 Lm **cód. 145827**

Ø:110 H:110 mm
Perforación:95 mm



Material Acero + ABS
1xGU10 MÁX 50W **cód. 147069**

- NO INCLUYE FOCO
- USO CON FOCO LED

Ø:180 H:180 mm
Perforación:176 mm



Material Aluminio
18W 3000K 1800 Lm **cód. 147592**

- ÁNGULO INTERIOR DIRIGIBLE DE 0 A 15° HACIA AMBOS LADOS



Luminarias Herméticas LED IP65

L:1275 W:114 H:56 mm



Material ABS - Policarbonato

2x18W 4000K 3240 Lm **cód. 147143**
2x18W 6500K 3240 Lm **cód. 147144**

L:1200 W:66 H:55 mm



Material ABS - Policarbonato

36W 6500K 3000 Lm **cód. 146336**

L:1240 W:51 H:44 mm



Material ABS - Policarbonato

36W 4000K 4320 Lm **cód. 147159**
36W 6500K 4320 Lm **cód. 147160**

L:600 W:70 H:56 mm / L:1200 W:70 H:56 mm



Material ABS - Policarbonato

20W 6500K 2400 Lm **cód. 147763**
40W 4000K 4800 Lm **cód. 147145**
40W 6500K 4800 Lm **cód. 147146**



Campanas High Bay LED

Ø:358 H:32 mm



Material Aluminio - Policarbonato

200W 6500K 20000 Lm **cód. 147723**

Ø:288.8 H:197 mm / Ø:332.7 H:202 mm



Material Aluminio - Policarbonato

150W 6000K 22500 Lm **cód. 147127**
200W 6000K 30000 Lm **cód. 147128**

Ø:299 H:184 mm



Material Aluminio - Policarbonato

100W-150W-200W 30K-40K-60K 15000-22500-30000 Lm **cód. 147801**

SELECCIÓN DE POTENCIAS Y TEMPERATURAS

100W	150W	200W
6000K	4000K	3000K

✓ CON SWITCH SELECTOR DE LUZ CÁLIDA, NEUTRA O FRÍA

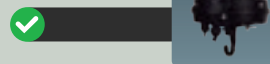

KIT DE EMERGENCIA PARA CAMPANAS HIGH BAY **cód. 147129**

Urbana LED

L:380 W:156 H:70 mm



Material Aluminio

60W 4000K 6000 Lm **cód. 145900**



Reflectores LED

L:136 W:23 H:97 mm
L:163 W:24 H:121 mm



Material Aluminio + Vidrio
30W 6500K 2700 Lm **cód. 147182**
50W 3000K 4500 Lm **cód. 147183**

L:164 W:79 H:167 mm
L:183 W:79 H:188 mm



Material Aluminio + Vidrio
30W 6500K 2850 Lm **cód. 147508**
50W 6500K 5000 Lm **cód. 147509**

L:231 W:31 H:160 mm



Material Aluminio + Acrílico
50W 6000K 5000 Lm **cód. 145311**



L:183 W:32 H:205 mm
L:217 W:33 H:244 mm
L:284 W:33 H:318 mm



Material Aluminio + Vidrio
50W 6500K 4500 Lm **cód. 146973**
100W 3000K 9000 Lm **cód. 147764**
100W 6500K 9000 Lm **cód. 146974**
200W 6500K 18000 Lm **cód. 146975**

L:253 W:31 H:284 mm
L:272 W:32 H:309 mm
L:297 W:32 H:338 mm
L:400 W:41 H:494 mm



Material Aluminio + Policarbonato
100W 6500K 11000 Lm **cód. 146936**
150W 6500K 16500 Lm **cód. 146948**
200W 6500K 22000 Lm **cód. 146937**
400W 6500K 44000 Lm **cód. 146949**

RESISTENTE PANTALLA DE POLICARBONATO

Reflectores LED con Trípode

Reflectores: L:175 H:130 mm

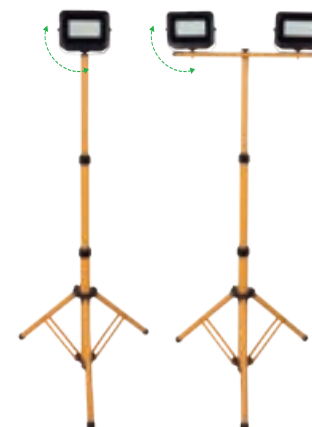

ALTURA REGULABLE HASTA 160 CM



APERTURA REGULABLE HASTA 78 CM



Material Aluminio + Vidrio
45W 6500K 4050 Lm **cód. 147504**
2x45W 6500K 8100 Lm **cód. 147505**

CABLE DE 3 METROS CON ENCHUFE TIPO B (MONOFASICO + TIERRA)

Luminarias de Emergencia y Salida LED

L:260 W:59 H:105 mm **PF >0.9** **50 MIL HORAS**



Material ABS + Poliestireno
2x1.2W 6500K 180 Lm **cód. 147800**
AUTONOMÍA: 3 HORAS

L:277 W:69 H:114 mm **PF >0.9**



Material Polipropileno + Poliestireno
2x1.2W 6500K 150 Lm **○** **cód. 147738**
2x1.2W 6500K 150 Lm **●** **cód. 147921**
AUTONOMÍA: 3 HORAS

L:280 W:113 H:298 mm **PF >0.9**



Material Polipropileno + Poliestireno
2x2W 6500K 280 Lm **cód. 147809**
AUTONOMÍA: 8 HORAS

L:277 W:69 H:114 mm **PF >0.9**



Material Polipropileno + Poliestireno
2x2W 6500K 200 Lm **cód. 147791**
AUTONOMÍA: 8 HORAS

Ø:130 H:61 mm **PF >0.9**



Material ABS
2x2W 6500K 160 Lm **cód. 148007**
AUTONOMÍA: 3 HORAS

✓ INSTALACIÓN ADOSADA



✓ INSTALACIÓN EMPOTRADA

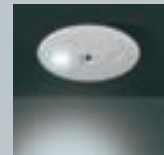

Ø1:141 mm
Ø2:84 mm **100LM/W** **50 MIL HORAS**



Material ABS
5W 7500K 500 Lm **cód. 146127**
***PRODUCTO A PEDIDO**
EMPOTRADO TIPO SPOT
AUTONOMÍA: 3 HORAS

L:351 W:117 H:78 mm **IP65** **50 MIL HORAS** **PF >0.9**



✓ INCLUYE STICKERS DE EVACUACIÓN



✓ 2 USOS: • LUZ DE EMERGENCIA
• LUZ PERMANENTE

Material ABS + Policarbonato
3W 7500K 128 Lm **cód. 147859**
AUTONOMÍA: 3 HORAS

L:255.5 W:90 H:50 mm **50 MIL HORAS** **PF >0.9**



Material ABS
3W **PF 0.5** 7500K 90 Lm **cód. 146126**
3W **PF 0.9** 7500K 90 Lm **cód. 147860**
AUTONOMÍA: 3 HORAS

L:260 W:226 H:27 mm **50 MIL HORAS**



✓ INCLUYE STICKERS DE SEÑALIZACIÓN



✓ SEÑAL DE DOS CARAS

✓ PARA PARED O TECHO

Material ABS
2W 7500K 6 Lm **cód. 147203**
AUTONOMÍA: 1.5 HORAS



NO NECESITAN
ENERGÍA ELÉCTRICA

Luminarias LED Solares

ESTACAS

Estaca:100 Ø:55 mm



Material Plástico
0.2 3000K 21 Lm **cód. 147423**

✓ CARGA: 8 HRS | AUTONOMÍA: 10 HRS

Estaca:100 Ø:75mm



Material Plástico
0.2 3000K 2 Lm **cód. 147421**

✓ CARGA: 7 HRS | AUTONOMÍA: 10 HRS

Estaca:100 Ø:90 mm



Material Acero inoxidable + Plástico
0.3W 3000K 7 Lm **cód. 147420**

✓ CARGA: 10 HRS | AUTONOMÍA: 10 HRS

Estaca:100 Ø:156 mm



Material Plástico
0.6 3000K 7 Lm **cód. 147422**

✓ CARGA: 7 HRS | AUTONOMÍA: 10 HRS

Estaca:150 L:100 mm



Material Policarbonato
1.8W 3000K -Luz Verde 200 Lm **cód. 147814**

✓ CARGA: 8 HRS | AUTONOMÍA: 4 HRS

✓ ADOSADA O TIPO ESTACA



✓ SWITCH SELECTOR DE 2 LUCES



APLIQUE

L:155 W:120 H:83 mm



Material Policarbonato
0.4W 3000K 50 Lm **cód. 147418**

✓ CARGA: 6 HORAS | AUTONOMÍA: 10 HORAS

REFLECTORES

L:300 W:86 H:70 mm



Material Policarbonato
4W 6500K 450 Lm **cód. 147419**

✓ CARGA: 6 HORAS | AUTONOMÍA: 10 HORAS

✓
INCLUYE
CONTROL
REMOTO



L:143 W:97 H:44 mm
L:194 W:97 H:44 mm



Material ABS + Vidrio
8W 30K-40K-65K 1000 Lm **cód. 147807** 10W 30K-40K-65K 1200 Lm **cód. 147808**

✓ CARGA: 6-8 HORAS | AUTONOMÍA: 75 MINUTOS

✓
SELECCIÓN DE INTENSIDAD
Y TEMPERATURA DE LUZ
(CÁLIDA, NEUTRA O FRÍA)



CARGA DE DÍA /
ILUMINA DE NOCHE



Bombillería LED

GU10 LED

<p>Ø:50 H:56 mm 60°</p>  <p>Material PBT + Policarbonato</p> <p>6W 3000K 520 Lm cód. 144063 6W 6000K 570 Lm cód. 144064 8W 3000K 580 Lm cód. 143708 8W 4000K 600 Lm cód. 145419 8W 6000K 728 Lm cód. 143296</p>	<p>Ø:50 H:56 mm 60° 106-112LM/W</p>  <p>Material PBT + Policarbonato</p> <p>8W Premium 3000K 850 Lm cód. 146166 8W Premium 6000K 900 Lm cód. 146167</p>	<p>Ø:50 H:56 mm DIM 60°</p>  <p>Material PBT + Policarbonato</p> <p>8W COB 3000K 580 Lm cód. 145383</p>	<p>Ø:50 H:56 mm PF >0.9 60°</p>  <p>Material PBT + Policarbonato</p> <p>8W 3000K 580 Lm cód. 147303 8W 6000K 728 Lm cód. 148017</p>	<p>Ø:50 H:56 mm 3 CCT 24°</p>  <p>Material Poliamida + Policarbonato</p> <p>6W 3000K-4000K-6000K 500 Lm cód. 147871</p> <p>✓ CON SWITCH SELECTOR DE LUZ CALIDA, NEUTRA O FRÍA</p>	<p>Ø:50 H:56 mm 3 CCT PF >0.9 60° 100LM/W</p>  <p>Material PBT + Policarbonato</p> <p>6W 3000K-4000K-6000K 600 Lm cód. 148045</p> <p>✓ CON SWITCH SELECTOR DE LUZ CALIDA, NEUTRA O FRÍA</p>
---	---	--	--	---	--

GU5.3 LED

Ø:50 H:48 mm
60°



Material PBT + Policarbonato

4W 3000K 300 Lm **cód. 144619**
 4W 6000K 340 Lm **cód. 144620**
 6W 3000K 430 Lm **cód. 143635**
 6W 6000K 450 Lm **cód. 143479**
 8W 3000K 560 Lm **cód. 143480**
 8W 6000K 580 Lm **cód. 143481**

G9 LED

Ø:16 H:52 mm
320°



Material Policarbonato

3W 2700K 260 Lm **cód. 143297**
 3W 6000K 280 Lm **cód. 143298**

Ø:19 H:58 mm
320° | 122LM/W



Material Policarbonato

4.5W 3000K 550 Lm **cód. 146500**

T26 E14 LED

Ø:25 H:59 mm
280°



Material Plástico + Policarbonato

1.5W 6500K 135 Lm **cód. 147510**

G45 E27 LED

Ø:45 H:86 mm
150°



Material Aluminio + Policarbonato

7W 3000K 560 Lm **cód. 146501**
 7W 6000K 580 Lm **cód. 146502**

A60 E27 LED

Ø:60 H:109 mm
220°
PF >0.9



Material PBT + Policarbonato
10W PF 0.5 3000K 880 Lm **cód. 144317**
10W PF 0.5 6000K 900 Lm **cód. 144318**
10W PF 0.9 3000K 880 Lm **cód. 148016**
10W PF 0.9 6000K 900 Lm **cód. 148016**

Ø:60 H:120 mm
SENSOR
200°



Material Plástico + Policarbonato
11W 6500K 1055 Lm **cód. 147511**
✓ CON SENSOR DE MOVIMIENTO

Ø:60 H:120 mm
DIM RGB 200°



Material PBT + Policarbonato
10W 2700K-6500K 806 Lm **cód. 146633**
✓ RGB - 16 MILLONES DE COLORES
✓ FOCO SMART CON APP **tuya**

Ø:60 H:109 mm
3 CCT 220°

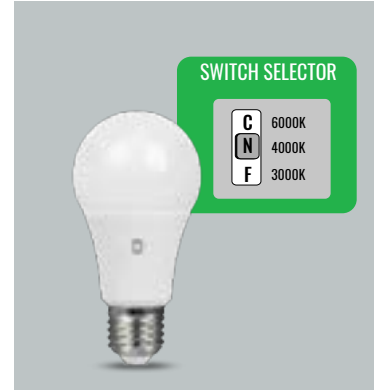

Material Poliamida + Policarbonato
10W 3000K-4000K-6500K 900 Lm **cód. 147827**
✓ CON SWITCH SELECTOR DE LUZ CÁLIDA, NEUTRA O FRÍA

GLOBOS E27 LED

Ø:95 H:127 mm
Ø:120 H:153 mm
200°



Material Policarbonato
12W 3000K 1100 Lm **cód. 133222**
12W 6000K 1200 Lm **cód. 133221**

C35 E14 LED

Ø:35 H:98 mm
300°
108LM/W

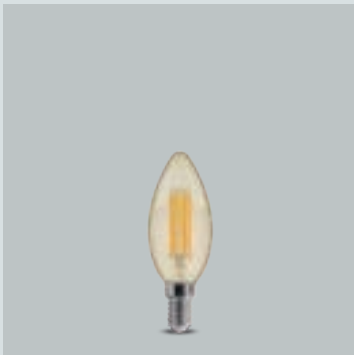

Material Vidrio
5W 2700K 540 Lm **cód. 146678**

G45 / G95 / G125 E27 LED

Ø:45 H:78 mm
Ø:95 H:140 mm
Ø:125 H:171 mm
300°
103LM/W



Material Vidrio
5W G45 2700K 540 Lm **cód. 146679**
7W G95 2700K 725 Lm **cód. 146682**
7W G125 2700K 725 Lm **cód. 146683**

ST64 E27 LED

Ø:64 H:140 mm
300°
103LM/W

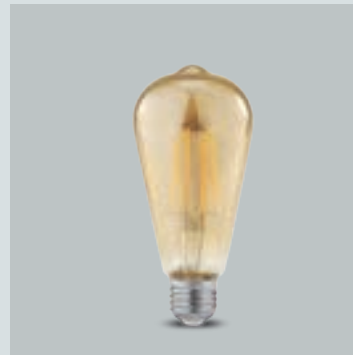

Material Vidrio
7W 2700K 725 Lm **cód. 146681**

A60 E27 LED

Ø:60 H:108 mm
300°
103LM/W

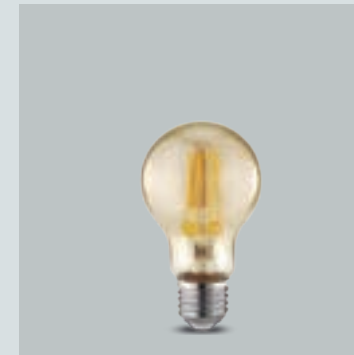

Material Vidrio
7W 2700K 725 Lm **cód. 146680**

PRISMA E27 LED

Ø:110 H:140 mm
360°
100LM/W



Material Vidrio
6W 2700K 600 Lm **cód. 147792**

UFOS E27 LED

Ø:143 H:76 mm
Ø:201 H:101 mm



PF
>0.9

Ø:292 H:120 mm



Ø:185 H:90 mm



UFOS METÁLICOS E27 LED

Ø:185 H:95 mm



Ø:185 H:102 mm



Material PBT + Policarbonato

15W PF 0.5 3000K 1350 Lm **cód. 146007**
15W PF 0.9 6000K 1350 Lm **cód. 147828**
20W PF 0.5 6000K 1900 Lm **cód. 146010**

30W 6000K 2800 Lm **cód. 146012**



Material Policarbonato

24W 6500K 1920 Lm **cód. 145390**



Material Aluminio + Policarbonato

30W 6500K 2400 Lm **cód. 145399**



EFECTO DE DESTELLOS

Material Aluminio + Policarbonato

30W 6500K 2500 Lm **cód. 147457**

CUBOS E27 LED

L:85 W:85 H:107 mm
L:95 W:95 H:122 mm



PAR38 E27 LED

Ø:121 H:121 mm



MINI HIGH POWER E27 LED

Ø:60 H:102 mm



Ø:70 H:106 mm



Material PBT

18W 3000K 1580 Lm **cód. 145621**
18W 6000K 1620 Lm **cód. 145622**
28W 6000K 2520 Lm **cód. 145623**

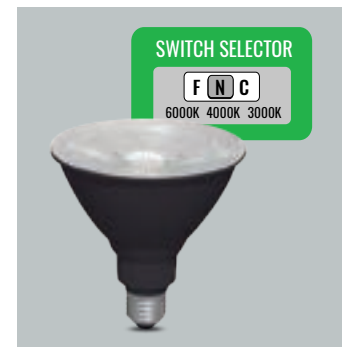

Material PBT + Policarbonato

15W 30K-40K-60K 1200 Lm **cód. 147912**

CON SWITCH SELECTOR DE LUZ CÁLIDA, NEUTRA O FRÍA



Material Plástico + Policarbonato

20W 3000K 1600 Lm **cód. 147573**
20W 6500K 1600 Lm **cód. 147572**

Material Plástico + Policarbonato

30W 6500K 2400 Lm **cód. 147574**

ALTA POTENCIA EN TAMAÑO COMPACTO

LUCES DE PASO

L:77 W:65 H:20 mm



Material PBT

18W 3000K 1580 Lm **cód. 145621**
18W 6000K 1620 Lm **cód. 145622**
28W 6000K 2520 Lm **cód. 145623**

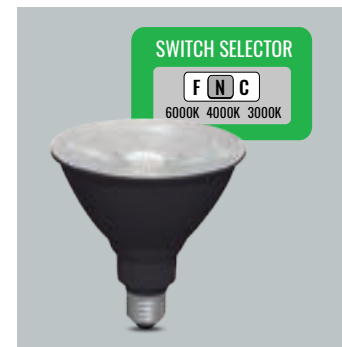

Material PBT + Policarbonato

15W 30K-40K-60K 1200 Lm **cód. 147912**

CON SWITCH SELECTOR DE LUZ CÁLIDA, NEUTRA O FRÍA



Material Plástico + Policarbonato

20W 3000K 1600 Lm **cód. 147573**
20W 6500K 1600 Lm **cód. 147572**

Material Plástico + Policarbonato

30W 6500K 2400 Lm **cód. 147574**

ALTA POTENCIA EN TAMAÑO COMPACTO



Material Policarbonato

1W 3000K 60 Lm **cód. 144677**
1W 3000K 60 Lm **cód. 148047**
1W 3000K 60 Lm **cód. 148048**

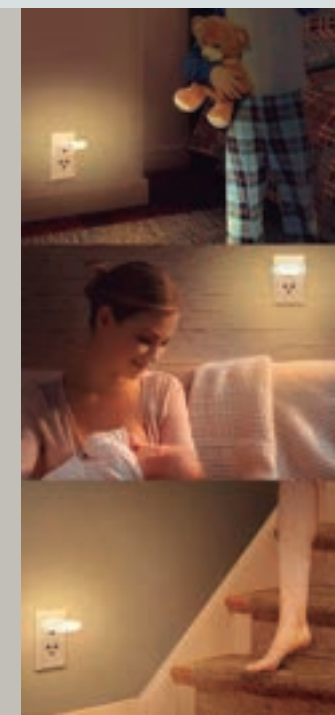

HIGH POWER E27 LED

Ø:80 H:155 mm
180°



Material Polipropileno
15W 6500K 1600 Lm **cód. 146232**

Ø:100 H:183 mm
180°



Material Polipropileno
26W 6500K 2560 Lm **cód. 145917**

Ø:120 H:205 mm
180°



Material Polipropileno
36W 6500K 3450 Lm **cód. 146260**

Ø:135 H:230 mm
180°



Material Polipropileno
45W 6500K 4300 Lm **cód. 145918**

Ø:150 H:255 mm
180°



Material Polipropileno
54W 6500K 5000 Lm **cód. 146725**

Tiras Flexibles LED

L:5000 H:100 mm | Rollo de 5 m
180°



Material Recubrimiento Siliconeado
50W (10W/m) 3000K 850 Lm/m **cód. 147122**

- ✓ 60 CHIPS x METRO | NO INCLUYE DRIVER
- ✓ DRIVER 36W (IP20) 12V **cód. 147125**



L:5000 H:100 mm | Rollo de 5 m
180°



Material Recubrimiento Siliconeado
50W COB (10W/m) 3000K 931 Lm/m **cód. 147124**
50W COB (10W/m) 4000K 975 Lm/m **cód. 147986**

- ✓ NO INCLUYE DRIVER
- DRIVER 72W (IP20) 12V **PFO.8** **cód. 147577**



L:5000 H:100 mm | Rollo de 5 m
L:10000 H:100 mm | Rollo de 10 m
180° IP65



Material Recubrimiento Siliconeado
50W COB (10W/m) 3000K 931 Lm/m **cód. 147378**
100W COB (10W/m) 3000K 931 Lm/m **cód. 147379**

- ✓ NO INCLUYE DRIVER
- ✓ DRIVER 80W (IP67) 12V **PFO.8** **cód. 147576**



Luminarias de Acento



Ø:160 mm | Altura regulable hasta 1200 mm

Material Aluminio + Metal + Acrílico

8W 3000K 640 Lm ● cód. 147520

8W 3000K 640 Lm ● cód. 147521

PF >0.9 | 50 MIL HORAS



Ø:80 H:190 mm | Altura regulable hasta 1000 mm

Material Aluminio + Policarbonato

25W 3000K 2000 Lm cód. 145288



L:200 H:200 mm | Altura regulable hasta 1500 mm

Material Metal con detalle en espejo + Acrílico

18W 3000K 1350 Lm ● cód. 147134

18W 3000K 1350 Lm ● cód. 146969



LUZ DIRECTA
E INDIRECTA

Ø:41 H:330 mm | Altura regulable hasta 1200 mm

Material Aluminio + Acrílico

7W 3000K 420 Lm ○ cód. 145656

7W 3000K 420 Lm ● cód. 145655



Ø:80 H:380 mm | Altura regulable hasta 1200 mm

Material Aluminio + Vidrio

6W 3000K 600 Lm cód. 146620



Ø:55 L:400 mm | Altura regulable hasta 1500 mm

Material Aluminio + Vidrio

5W 3000K 500 Lm cód. 146158



Ø:60 H:300 mm | Altura regulable hasta 1520 mm

Material Aluminio

1xGU10 MÁX 40W | No incluye foco ○ cód. 147162

1xGU10 MÁX 40W | No incluye foco ● cód. 147163

1xGU10 MÁX 40W | No incluye foco ● cód. 147164

Luminarias Suspendidas

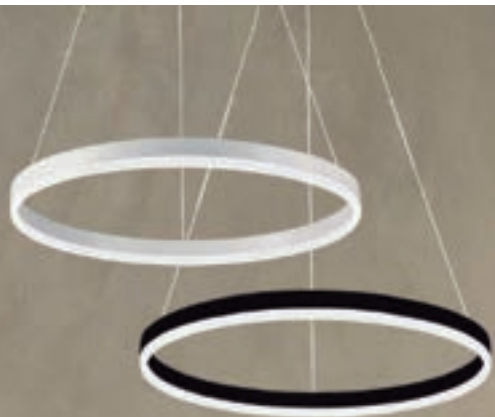

Ø:600 mm | Altura regulable hasta 1200 mm

Material Aluminio + Acrílico

30W 3000K 1890 Lm ● **cód. 146929**

30W 3000K 1890 Lm ● **cód. 146930**



L:820 mm | Altura regulable hasta 1200 mm

Material Aluminio + Metal + Acrílico

24W 3000K 1920 Lm **cód. 147522**

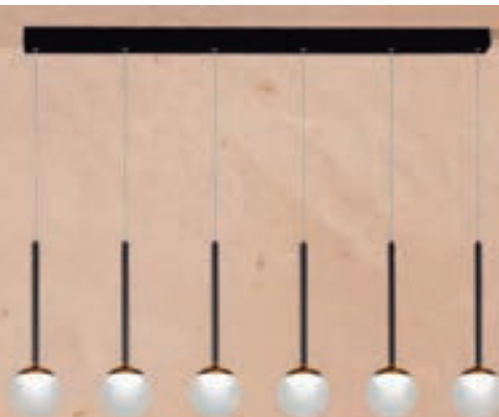

L:1100 mm | Altura regulable hasta 2100 mm

Material Aluminio + Metal + Acrílico

42W 3000K 2900 Lm **cód. 146734**



Ø1:400 Ø2:600 Ø3:800 mm | Altura regulable hasta 1800 mm

Material Metal + Aluminio + Recubrimiento Siliconeado

114W 3000K 11183 Lm **cód. 146629**



L:380 mm / L:1000 mm | Alturas regulable hasta 1500 mm

Material Aluminio + Vidrio

24W 3000K 2400 Lm **cód. 146151**

60W 3000K 6000 Lm **cód. 146152**



Ø:455 mm | Altura regulable hasta 1100 mm

Material ABS + Acrílico + Metal

36W 3000K 2520 Lm ● **cód. 146954**

36W 3000K 2520 Lm ○ **cód. 146952**



L:665 mm | Altura regulable hasta 1200 mm

Material Metal + Acrílico

32W 3000K 2560 Lm ● **cód. 147524**

32W 3000K 2560 Lm ● **cód. 147523**



L:1200 mm | Altura regulable hasta 1200 mm

Material Aluminio + Silicona

44W 3000K 2100 Lm **cód. 147962**



Ø:600 mm | Altura regulable hasta 1000 mm

Material Aluminio

42W 3000K 2520 Lm ● **cód. 147008**
 42W 3000K 2520 Lm ● **cód. 148001**



Ø:400 mm | Altura regulable hasta 1200 mm

Material Aluminio

1xE27 MÁX 60W | No incluye foco ● **cód. 146842**
 1xE27 MÁX 60W | No incluye foco ● **cód. 145902**



L:900 mm | Altura regulable hasta 900 mm

Material Metal + Vidrio

6xG9 MÁX 33W | No incluye focos **cód. 147103**



Ø:400 mm | Altura regulable hasta 1200 mm

Material Aluminio

6xE27 MÁX 60W | No incluye focos **cód. 147007**



L:600 mm | Altura regulable hasta 1200 mm

Material Metal

3xE27 MÁX 40W | No incluye focos **cód. 146520**



Ø:300 mm | Altura regulable hasta 1200 mm

Material Metal + Vidrio

1xE27 MÁX 40W | No incluye foco **cód. 147939**



Ø:273 mm | Altura regulable hasta 1200 mm

Material Aluminio + Silicona + Vidrio color ambar

12W + 1xG9 3000K 960 Lm **cód. 147516**
 Máx.40W | Incluye esfera de vidrio | No incluye foco



Ø:250 H:250 mm | Altura regulable hasta 1200 mm

Material Aluminio + Metal

1xE27 MÁX 40W | No incluye foco ● **cód. 146513**
 1xE27 MÁX 40W | No incluye foco ● **cód. 146512**
 1xE27 MÁX 40W | No incluye foco ● **cód. 146511**



Ø:380 mm | Altura regulable hasta 1270 mm
Material Metal + Bambú
1xE27 MÁX 40W | No incluye foco **cód. 147469**



Ø:300 mm | Altura regulable hasta 1300 mm
Material Metal + Bambú
1xE27 MÁX 40W | No incluye foco **cód. 147470**



Ø:230 mm | Altura regulable hasta 1360 mm
Material Metal + Bambú
1xE27 MÁX 40W | No incluye foco **cód. 147471**



L:600 mm | Altura regulable hasta 1300 mm
Material Metal + Bambú
1xE27 MÁX 40W | No incluye foco **cód. 147472**

Luminarias de Doble Altura



Ø:460 mm | Altura regulable hasta 2100 mm
Material Aluminio + Metal + Acrílico
42W 3000K 2900 Lm **cód. 146735**



Ø:850 mm | Altura regulable hasta 2100 mm
Material Aluminio + Vidrio soplado
18xE14 MÁX 40W | No incluye focos **cód. 146863**

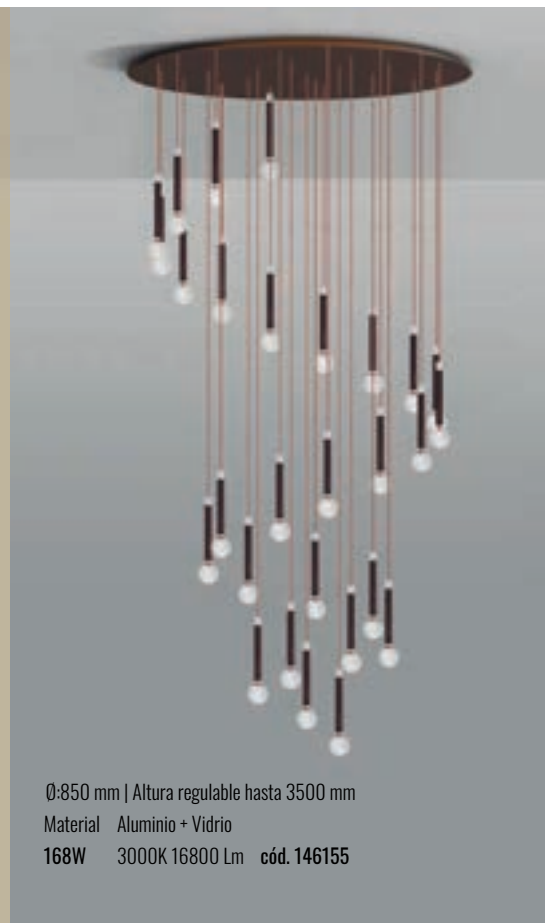

Ø:850 mm | Altura regulable hasta 3500 mm
Material Aluminio + Vidrio
168W 3000K 16800 Lm **cód. 146155**



Ø:400 mm | Altura regulable hasta 2100 mm
Material Metal + Vidrio
10xE27 MÁX 40W | No incluye focos **cód. 147102**

Protección contra ingresos de polvo y agua

IP65



CONTRA INGRESO DE POLVO

0		Ninguna protección
1		Protegido frente a objetos sólidos ≥ 50 mm
2		Protegido frente a objetos sólidos ≥ 12.5 mm
3		Protegido frente a objetos sólidos ≥ 2.5 mm
4		Protegido frente a objetos sólidos ≥ 1 mm
5		Protegido frente a la suciedad
6		Hermético. Total protección frente a la suciedad

CONTRA INGRESO DE AGUA

0		Ninguna protección
1		Protegido frente a goteos verticales
2		Protegido frente a goteos que caen verticales $<15^\circ$
3		Protegido frente a agua pulverizada
4		Protegido frente a salpicaduras
5		Protegido frente a chorros de agua a presión
6		Protegido frente a fuertes chorros de agua a presión
7		Protegido frente a inmersiones de 1 m de profundidad durante 30 min
8		Protegido frente a inmersiones de alta presión y temperatura

Conoce nuestra línea de
Iluminación Arquitectónica

ARKOSLIGHT
HECHO EN ESPAÑA



CONOCE MÁS SOBRE
NUESTROS PRODUCTOS



LIGHTTECH

- » TECNOLOGÍA LED
- » VARIEDAD Y AMPLIO STOCK

- 📍 Av. Felipe Pardo y Aliaga 422,
San Isidro. Lima - Perú
- ☎ 981 333 072
- ✉ ventas@lumicenter.com.pe
- 🌐 lumicenter.com.pe
- 📘 LumicenterPeru
- 📷 LumicenterPeru

Lumi
CENTER

- » DESARROLLO DE PROYECTOS
- » ASESORÍA ESPECIALIZADA