

ILUMINACIÓN LED 2024

LIGHTTECH



- 📍 Av. Felipe Pardo y Aliaga 422,
San Isidro. Lima - Perú
- ☎ 981 333 072
- ✉ ventas@lumicenter.com.pe
- 🌐 lumicenter.com.pe
- 📘 LumicenterPeru
- 📷 LumicenterPeru



Lumicenter

Desarrollamos proyectos integrales de iluminación en diferentes sectores e industrias a nivel nacional.

Nuestra marca **LIGHTTECH®** ofrece alta tecnología LED, eco-amigable y eficiente; con el portafolio de luminarias más completo del mercado.



Propuesta de Valor

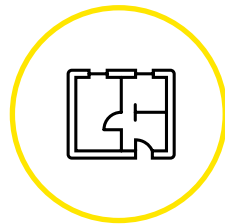

Desarrollo de propuesta y cálculos lumínicos

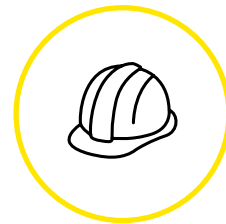

Profesionales en iluminación



Amplio surtido y stock permanente

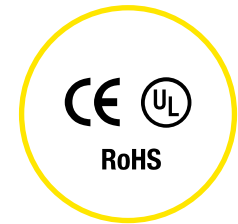

Certificaciones internacionales

Índice de Contenidos

04

Spots



06

Downlights

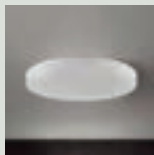

09

Paneles



10

Lineales y Undercabinets

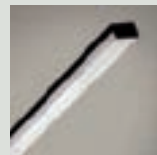

11

Proyectores y rieles

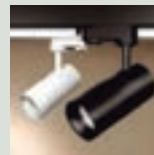

12

Línea Magnet



14

Lineales suspendidos



16

Apliques interiores

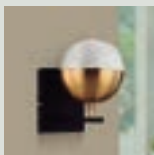

18

Plafones



20

Apliques exteriores



22

Luces Guía

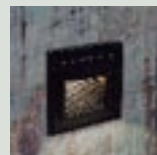

23

Estacas



24

Guirnaldas



Embutidos de piso

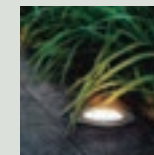

Postes de piso

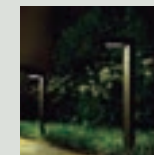

25

Luminarias herméticas



Campanas High Bay

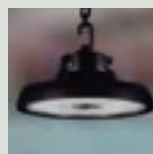

Urbanas



26

Reflectores



27

Luminarias de Emergencia y Salida



28

Bombillería



31

Tiras Flexibles

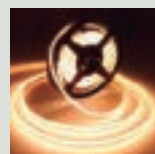

32

Luminarias Decorativas



Como leer la información de los productos

Dimensiones del producto

Ø: Diámetro L: Largo

W: Ancho H: Profundidad

Íconos de características principales

Ø:259.5 H:185.5 mm



DIM



IP65



Material del producto

Potencia en Watts

Material Aluminio + Policarbonato
100W 6000K 14000 Lm **cód. 146345**

Temperatura de color de luz



2700K 3000K 4000K 6000K 6500K

Lúmenes

Código SKU

Iconografía



DIM

Dimerizable



IP65

Índice de protección contra agua y polvo



3 LUCES

Selector de color de luz por interruptor



SENSOR

Con sensor de movimiento



Dirección de haz de luz



36°

Ángulo de apertura



100LM/W

Eficiencia lumínica



SOLAR

Tecnología LED con panel solar



RGB

Luz LED RGB multicolor



PF >0.9

Alto factor de Potencia 0.9



3 CCT

Selector de color de luz por switch



50 MIL HORAS

Larga vida útil de 50 mil horas



Sectores que atendemos



Residencial

- Recepciones y halls
- Ambientes interiores
- Salones multiuso
- Fachadas y jardines
- Terrazas y balcones
- Sótanos
- Áreas recreativas
- Gimnasios
- Áreas comunes

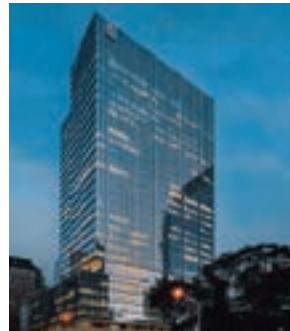

Corporativo

- Coworkings
- Oficinas
- Centros empresariales
- Centros de convenciones
- Clubes



Comercial

- Restaurantes y cafeterías
- Tiendas por departamento
- Galerías y museos
- Hoteles
- Áreas de esparcimiento y canchas deportivas



Educativo

- Aulas
- Bibliotecas y laboratorios
- Oficinas
- Recepciones y halls
- Salones multiuso
- Fachadas y exteriores
- Coliseos y estadios



Salud

- Recepciones
- Consultorios
- Salas de espera
- Laboratorios
- Fachadas y zonas exteriores



Industrial

- Centros de distribución
- Naves industriales
- Fábricas
- Talleres de producción
- Almacenes

Certificaciones internacionales



Conformidad Europea certifica que los productos evaluados cumplen los requisitos de seguridad, sanidad y protección del medio ambiente exigidos por la Unión Europea.



Underwriters Laboratories certifica el cumplimiento de estándares de calidad; teniendo como objetivo reducir el riesgo de incendios y descargas eléctricas.

RoHS

ROHS garantiza la restricción de sustancias peligrosas (metales pesados) en aparatos electrónicos. Promueve el reciclaje, la reutilización y la recuperación de residuos.

Spots Empotrados

Spots No integrados

Ø:82 H:35 mm | Perforación:72 mm



Material Aluminio
1xGU10 MÁX 50W **cód. 147404**
✓ SEMI RECESADO

Ø:92 H:25 mm | Perforación:80 mm

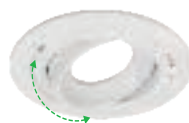

Material Aluminio
1xGU10 MÁX 50W **cód. 147340**

Ø:101 H:50 mm | Perforación:95 mm



Material Aluminio
1xGU10 MÁX 50W ○ **cód. 147615**
1xGU10 MÁX 50W ● **cód. 147885**
✓ RECESADOS

Ø:98 H:58 mm | Perforación:90 mm



Material Aluminio
1xGU10 MÁX 50W ○ **cód. 144948**
1xGU10 MÁX 50W ● **cód. 145558**
✓ RECESADOS

Ø:82 H:25 mm | Perforación:72 mm
Ø:108 H:25 mm | Perforación:67 mm



Material Zamac
1xGU10 MÁX 50W ○ **cód. 144615**
1xGU10 MÁX 50W ● **cód. 144616**
1xGU10 MÁX 50W ● **cód. 144618**

Ø:105 H:30 mm | Perforación:85 mm

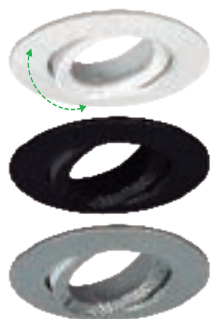

Material Plástico
1xGU10 ○ **cód. 147824**
1xGU10 ● **cód. 147825**
1xGU10 ● **cód. 147826**
✓ USO CON FOCO LED

Ø:110 H:29 mm | Perforación:80 mm

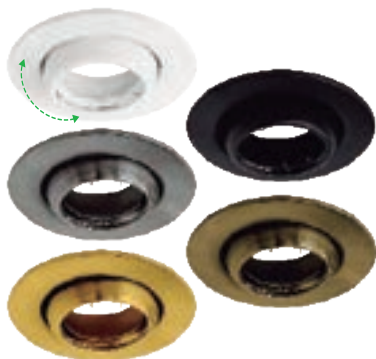

Material Metal
1xGU10 MÁX 50W ○ **cód. 144601**
1xGU10 MÁX 50W ● **cód. 144567**
1xGU10 MÁX 50W ● **cód. 144603**
1xGU10 MÁX 50W ● **cód. 144602**
1xGU10 MÁX 50W ● **cód. 144952**

Ø:110 H:25 mm | Perforación:80 mm

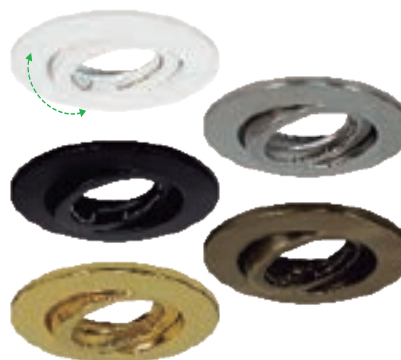

Material Metal
1xGU10 MÁX 50W ○ **cód. 144604**
1xGU10 MÁX 50W ● **cód. 144605**
1xGU10 MÁX 50W ● **cód. 144606**
1xGU10 MÁX 50W ● **cód. 144566**
1xGU10 MÁX 50W ● **cód. 145276**

L:92 W:92 H:25 mm | Perforación:79x79 mm
L:115 W:115 H:55 mm | Perforación:90x90 mm

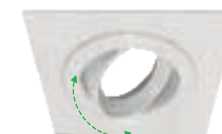

Material Aluminio
1xGU10 MÁX 50W **cód. 144735**
Material Metal
1xGU10 MÁX 50W **cód. 69543**

Spot Hermético

Ø:84 H:42 mm | Perforación:68 mm

IP44



Material Aluminio
1xGU10 MÁX 50W **cód. 144950**

Spots LED

Ø:60 H:30 mm | Perforación:50 mm



Material Policarbonato
 3W 3000K 280 Lm **cód. 144621**
 3W 6000K 300 Lm **cód. 144642**

✓ IDEAL PARA MUEBLES

Ø:105 H:45 mm | Perforación:85 mm

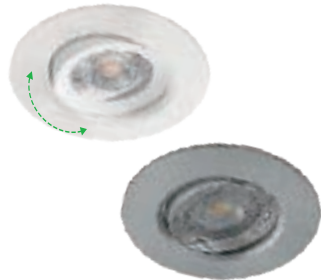

Material Policarbonato
 5W COB 3000K 400 Lm ○ **cód. 147363**
 5W COB 6000K 425 Lm ○ **cód. 147364**
 7W COB 3000K 550 Lm ○ **cód. 147339**
 7W COB 6000K 580 Lm ○ **cód. 147362**
 7W COB 3000K 550 Lm ● **cód. 147365**
 7W COB 6000K 580 Lm ● **cód. 147402**
 10W COB 3000K 850 Lm ○ **cód. 147403**
 10W COB 6000K 850 Lm ○ **cód. 147725**

Ø:105 H:45 mm | Perforación:85 mm

3 CCT

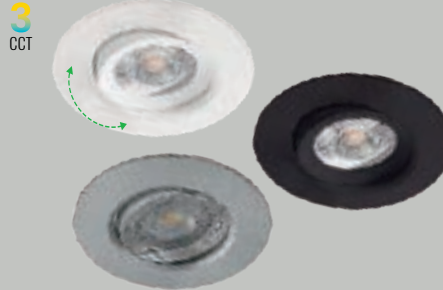

Material Policarbonato
 5W COB 3000K-4000K-6000K 400 Lm ○ **cód. 147849**
 7W COB 3000K-4000K-6000K 580 Lm ○ **cód. 147850**
 7W COB 3000K-4000K-6000K 580 Lm ● **cód. 147851**
 7W COB 3000K-4000K-6000K 580 Lm ● **cód. 147911**
 10W COB 3000K-4000K-6000K 850 Lm ○ **cód. 147852**

✓ CON SWITCH SELECTOR DE LUZ CÁLIDA, NEUTRA O FRÍA

Ø:109 H:81 mm | Perforación:80-95 mm



Material Policarbonato
 8W 3000K 500 Lm **cód. 146237**
 8W 6000K 520 Lm **cód. 146238**

✓ INCLUYE FOCO GU10

Ø:103 H:90 mm | Perforación:95 mm

IP44 DIM



Material Policarbonato
 9W DIM 3000K 600 Lm ○ **cód. 146168**
 9W DIM 3000K 480 Lm ● **cód. 146169***
 *PRODUCTO A PEDIDO

✓ RECESADO

Ø:105 H:31 mm | Perforación:90 mm



Material Policarbonato
 9W 3000K 810 Lm **cód. 146080**

Ø:110 H:36 mm | Perforación:98 mm



Material Metal
 9W 3000K 720 Lm ○ **cód. 145947**
 9W 6000K 740 Lm ○ **cód. 145948**
 9W 3000K 720 Lm ● **cód. 145949**
 9W 6000K 740 Lm ● **cód. 145950**
 14W 6000K 1120 Lm ○ **cód. 146985**
 14W 6000K 1120 Lm ● **cód. 146986**

✓ PARA CAJA OCTOGONAL

Ø:110 H:36 mm | Perforación:98 mm

3 CCT



Material Metal
 9W 3000K-4000K-6000K 720 Lm ○ **cód. 147846**
 9W 3000K-4000K-6000K 720 Lm ● **cód. 147845**
 9W 3000K-4000K-6000K 720 Lm ● **cód. 147910**
 14W 3000K-4000K-6000K 1120 Lm ○ **cód. 147848**
 14W 3000K-4000K-6000K 1120 Lm ● **cód. 147847**

✓ PARA CAJA OCTOGONAL

✓ CON SWITCH SELECTOR DE LUZ CÁLIDA, NEUTRA O FRÍA

L:105 W:105 H:44 mm | Perforación:72 mm



Material Policarbonato
 7W COB 3000K 550 Lm **cód. 147477**
 7W COB 6000K 580 Lm **cód. 147507**

L:105 W:105 H:44 mm | Perforación:72x72 mm

3 CCT



Material Policarbonato
 7W COB 3000K-4000K-6000K 580 Lm **cód. 147853**

✓ CON SWITCH SELECTOR DE LUZ CÁLIDA, NEUTRA O FRÍA

Spots Adosados

Ø:80 H:125 mm



Material Policarbonato
1xGU10 ○ cód. 146505
1xGU10 ● cód. 146506



L:80 W:80 H:125 mm



Material Policarbonato
1xGU10 ○ cód. 147200
1xGU10 ● cód. 147201



Ø Base:144 Ø:58 H:85 mm



Material Policarbonato
1xGU10 ● cód. 147823
1xGU10 ○ cód. 147822



Ø Base:110 Ø:60 H:75 mm



Material Policarbonato
7W 3000K 540 Lm ● cód. 146084
7W 6500K 560 Lm ● cód. 146085
7W 3000K 540 Lm ○ cód. 146082
7W 6500K 560 Lm ○ cód. 146083

Ø Base:120 Ø:60 H:75 mm
L Base:250 W:59 H:90 mm



Material Policarbonato
2x7W 3000K 1100 Lm ○ cód. 146486
3x7W 3000K 1575 Lm ● cód. 146487

Downlights Empotrados LED

Ø:150 H:60 mm | Perforación:120 mm
Ø:221 H:26 mm | Perforación:187 mm
Ø:200 H:60 mm | Perforación:170 mm
Ø:230 H:60 mm | Perforación:200 mm

PF
>0.9



Material Policarbonato
15W 4000K 1200 Lm cód. 147614
18W 6000K 1620 Lm cód. 147778
25W 3000K 2050 Lm cód. 147613
25W 4000K 2150 Lm cód. 147566
30W 4000K 2400 Lm cód. 147562

Ø:170 H:40 mm | Perforación:150 mm
Ø:300 H:47 mm | Perforación:270 mm

3 CCT | PF
>0.9



Material Policarbonato
12W 3000K-4000K-6000K 1200 Lm cód. 147815
24W 3000K-4000K-6000K 2400 Lm cód. 147816



Downlights Adosados o Empotrados LED

Ø Base:92 H:77 mm

3 CCT



Material Policarbonato
6W 3000K-4000K-6000K 600 Lm ● cód. 147498
6W 3000K-4000K-6000K 600 Lm ○ cód. 147497

✓ INSTALACIÓN ADOSADA CON CILINDRO



✓ INSTALACIÓN EMPOTRADA SIN CILINDRO



Downlights Adosados o Empotrados LED

Ø:147 H:120 mm
 Ø:176 H:130 mm
 Ø:231 H:160 mm





 **INSTALACIÓN ADOSADA CON CILINDRO**



 **INSTALACIÓN EMPOTRADA SIN CILINDRO**



Material Aluminio + Metal

15W	3000K-4000K-6000K 1200 Lm	cód. 145908
20W	3000K-4000K-6000K 1640 Lm	cód. 145909
35W	3000K-4000K-6000K 2800 Lm	cód. 145910

 **CON SWITCH SELECTOR DE LUZ CÁLIDA, NEUTRA O FRÍA**

Luminarias Adosados LED (Frameless)

2 TIPOS DE INSTALACIÓN

 **EMPOTRADO CON CLIPS**



 **ADOSADO CON BASE DE FIJACIÓN**



Ø:120 H:35 mm
 Ø:170 H:35 mm
 Ø:220 H:33.6 mm

L:169 W:169 H:32.6 mm

Material	Policarbonato		Material	Policarbonato	
17W	3000K 1700 Lm	cód. 146958	24W	3000K 2160 Lm	cód. 146442
17W	6500K 1700 Lm	cód. 146976	24W	6500K 2400 Lm	cód. 147355
24W	3000K 2400 Lm	cód. 146944			
24W	4000K 2400 Lm	cód. 146945			
24W	6500K 2400 Lm	cód. 146946			
32W	3000K 2880 Lm	cód. 146440			
32W	6500K 3200 Lm	cód. 147112			

Downlights Adosados LED

INSTALACIÓN

 **ADOSADO CON CRUCETA**

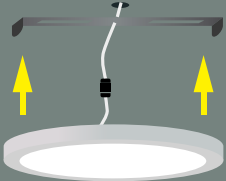



Ø:111 H:28 mm
 Ø:160 H:28 mm
 Ø:210 H:28 mm

Ø:123 H:35 mm
 Ø:174 H:35 mm
 Ø:226 H:35 mm
 Ø:300 H:32 mm

Ø:121 H:32 mm
 Ø:230 H:32 mm
 Ø:302 H:32 mm



Ø:121 H:32 mm
 Ø:178 H:32 mm
 Ø:230 H:32 mm
 Ø:302 H:32 mm

L:159 W:159 H:28 mm

Material	Aluminio + Poliestireno		Material	Polipropileno + Poliestireno		Material	Polipropileno + Poliestireno				
6W	3000K 470 Lm	○	cód. 146493	6W	3000K 480 Lm	○	cód. 146670	6W	6500K 480 Lm	○	cód. 147767
6W	6000K 480 Lm	○	cód. 146355	12W	3000K 960 Lm	○	cód. 146672	18W	3000K 1620 Lm	○	cód. 147768
6W	6000K 480 Lm	●	cód. 147138	18W	3000K 1620 Lm	○	cód. 147620	18W	4000K 1620 Lm	○	cód. 147769
12W	6000K 960 Lm	●	cód. 147139	18W	6500K 1620 Lm	○	cód. 147622	18W	6500K 1620 Lm	○	cód. 147770
18W	3000K 1440 Lm	○	cód. 146357	24W	3000K 2040 Lm	○	cód. 146677	24W	3000K 2040 Lm	○	cód. 147772
18W	6000K 1440 Lm	●	cód. 147140	24W	6500K 2040 Lm	○	cód. 147413	24W	4000K 2040 Lm	○	cód. 147771
								24W	6500K 2040 Lm	○	cód. 147773

 **CON SWITCH SELECTOR DE LUZ CÁLIDA, NEUTRA O FRÍA**

MARCO DE ALUMINIO

MARCO DE POLIPROPILENO

MARCO DE ALUMINIO

Material Aluminio + ABS

12W	6000K 960 Lm	cód. 146356
-----	--------------	-------------

Downlights Adosados LED con 2 Tipos de Instalación

2 TIPOS DE INSTALACIÓN

✓ EMPOTRADO CON CLIPS



✓ ADOSADO CON CRUCETA



Ø:167 H:17 mm
Ø:220 H:17.8 mm

SENSOR | PF >0.9



Material Policarbonato + Polipropileno

12W 3000K 960 Lm **cód. 147484**
12W 6000K 960 Lm **cód. 147485**
18W 3000K 1500 Lm **cód. 146337**
18W 6000K 1600 Lm **cód. 146338**

✓ MARCO DE POLICARBONATO

Ø:167 H:17 mm
Ø:220 H:17.8 mm

3 CCT | SENSOR | PF >0.9



Material Policarbonato + Polipropileno

12W 3000K-4000K-6000K 1030 Lm **cód. 147841**
18W 3000K-4000K-6000K 1600 Lm **cód. 147843**

✓ MARCO DE POLICARBONATO

✓ CON SWITCH SELECTOR DE LUZ CALIDA, NEUTRA O FRÍA

Ø:167 H:17.8 mm
Ø:298 H:17.8 mm



Material Polímero Termoplástico + Policarbonato

12W 6000K 1100 Lm **cód. 146120**
24W 6000K 1900 Lm **cód. 146497**

✓ MARCO DE POLÍMERO

Ø:126 H:17.8 mm
Ø:167 H:17.8 mm
Ø:220 H:17.8 mm
Ø:298 H:17.8 mm

PF >0.9



Material Polímero Termoplástico + Polipropileno

9W 3000K 585 Lm **cód. 147347**
9W 6000K 630 Lm **cód. 147312**
12W 3000K 1030 Lm **cód. 147348**
12W 6000K 1100 Lm **cód. 147349**
18W 3000K 1500 Lm **cód. 147302**
18W 4000K 1600 Lm **cód. 147334**
18W 6000K 1600 Lm **cód. 147301**
24W 3000K 1800 Lm **cód. 147350**
24W 6000K 1900 Lm **cód. 147351**

✓ MARCO DE POLÍMERO

Ø:126 H:17.8 mm
Ø:167 H:17.8 mm
Ø:220 H:17.8 mm
Ø:298 H:17.8 mm

3 CCT | PF >0.9



Material Policarbonato + Polipropileno

9W 3000K-4000K-6000K 600 Lm **cód. 147839**
12W 3000K-4000K-6000K 1030 Lm **cód. 147840**
18W 3000K-4000K-6000K 1600 Lm **cód. 147842**
24W 3000K-4000K-6000K 1800 Lm **cód. 147844**

✓ MARCO DE POLICARBONATO

✓ CON SWITCH SELECTOR DE LUZ CALIDA, NEUTRA O FRÍA

Ø:121 H:32 mm
Ø:230 H:32 mm

PF >0.9



Material ABS + Polipropileno

9W 3000K 810 Lm **cód. 147774**
9W 6500K 810 Lm **cód. 147775**
18W 3000K 1620 Lm **cód. 147776**
18W 6500K 1620 Lm **cód. 147777**

✓ INSTALACIÓN ADOSADA

Ø:220 H:17.8 mm

3 CCT | SENSOR | PF >0.9



Material Policarbonato + Polipropileno

18W 3000K-4000K-6000K 1530 Lm **cód. 147869**

✓ MARCO DE POLICARBONATO

✓ CON SWITCH SELECTOR DE LUZ CALIDA, NEUTRA O FRÍA

Ø:126 H:17.8 mm
Ø:220 H:17.8 mm
Ø:298 H:17.8 mm

3 CCT | PF >0.9



Material Policarbonato + Polipropileno

9W 3000K-4000K-6000K 630 Lm **cód. 147867**
18W 3000K-4000K-6000K 1260 Lm **cód. 147868**
24W 3000K-4000K-6000K 1800 Lm **cód. 147870**

✓ MARCO DE POLICARBONATO

✓ CON SWITCH SELECTOR DE LUZ CALIDA, NEUTRA O FRÍA



Paneles Empotrados LED

L:595 W:595 H:30 mm

PF >0.9 111LM/W 50 MIL HORAS IP40



Material Aluminio + Poliestireno

36W 4000K 4000 Lm **cód. 147121**
36W 6500K 4000 Lm **cód. 147120**

✓ TECNOLOGÍA BACKLIT

L:595 W:595 H:30 mm

3 CCT PF >0.9 120LM/W 50 MIL HORAS IP40



Material Aluminio + Poliestireno

36W 3000K-4000K-6000K 4320 Lm **cód. 147793**

✓ TECNOLOGÍA BACKLIT

✓ SWITCH SELECTOR DE LUZ CÁLIDA, NEUTRA O FRÍA

L:595 W:595 H:30 mm

3 CCT PF >0.9



Material Aluminio + Poliestireno

48W 3000K-4000K-6000K 4320 Lm **cód. 147794**

✓ TECNOLOGÍA BACKLIT

✓ SWITCH SELECTOR DE LUZ CÁLIDA, NEUTRA O FRÍA

L:1195 W:295 H:30 mm

3 CCT PF >0.9 111LM/W 50 MIL HORAS IP40



Material Aluminio + Poliestireno

36W 3000K-4000K-6000K 4000 Lm **cód. 147743**

✓ TECNOLOGÍA BACKLIT

✓ CON SWITCH SELECTOR DE LUZ CÁLIDA, NEUTRA O FRÍA

L:1195 W:295 H:30 mm

PF >0.9



Material Aluminio + Polipropileno

48W 4000K 4320 Lm **cód. 146241**
48W 6000K 4320 Lm **cód. 146737**

✓ TECNOLOGÍA BACKLIT

L:595 W:595 H:90 mm

PF >0.9 108LM/W

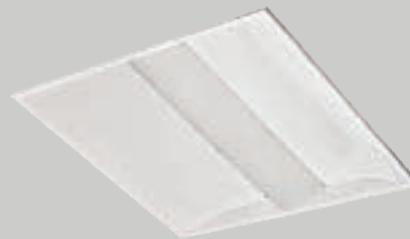

Material Acero + PMMA

35W 4000K 3800 Lm **cód. 145256**

L:595 W:595 H:30 mm

DIM PF >0.9 100LM/W 50 MIL HORAS

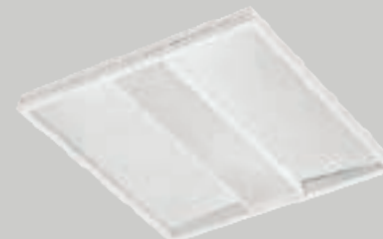

Material Aluminio

40W 4000K 4000 Lm **cód. 145394**

✓ DIMERIZABLE DE 0/1-10V

✓ UGR (ANTI DESLUMBRAMIENTO)

Accesorios



MARCO ADOSADO 60x60 CM Material: Aluminio **cód. 146911**



MARCO ADOSADO 30x120 CM Material: Aluminio **cód. 146878**



KIT DE SUSPENSIÓN **cód. 146236**

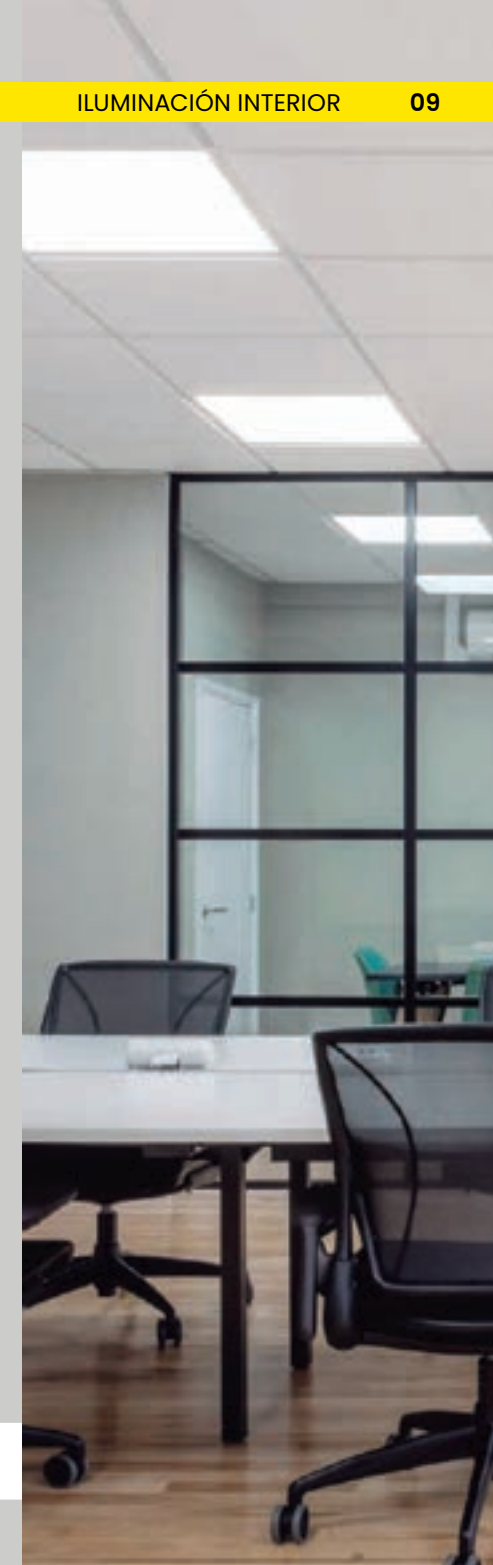

Paneles Adosados LED

L:600 W:600 H:38 mm
PF >0.9



Material Aluminio + Polipropileno
48W 6000K 4320 Lm **cód. 146391**

L:600 W:600 H:38 mm
3 CCT | PF >0.9



Material Aluminio + Polipropileno
48W 3000K-4000K-6000K 4320 Lm **cód. 147795**

✓ CON SWITCH SELECTOR DE LUZ CALIDA, NEUTRA O FRÍA

L:1200 W:300 H:50 mm
PF >0.9



Material Aluminio + Polipropileno
48W 6000K 3840 Lm **cód. 146235**

L:1200 W:300 H:38 mm
3 CCT | PF >0.9



Material Aluminio + Polipropileno
48W 3000K-4000K-6000K 4320 Lm **cód. 147796**

✓ CON SWITCH SELECTOR DE LUZ CALIDA, NEUTRA O FRÍA

L:1200 W:150 H:36 mm
PF >0.9



Material Aluminio + Policarbonato
48W 6000K 4000 Lm **cód. 146496**

Lineales Adosados LED

L:590 W:40 H:60 mm
L:1190 W:40 H:60 mm
PF >0.9 | 100LM/W



LED INTEGRADO

Material Policarbonato
18W 6500K 1800 Lm ○ **cód. 147563**
18W 6500K 1800 Lm ● **cód. 147878**
36W 6500K 3600 Lm ○ **cód. 147564**
36W 6500K 3600 Lm ● **cód. 147565**

L:600 W:24 H:74 mm
L:1200 W:24 H:75 mm
100LM/W



LED INTEGRADO

Material Policarbonato
SLIM 18W 6500K 1800 Lm ○ **cód. 147542**
SLIM 18W 6500K 1800 Lm ● **cód. 147916**
SLIM 18W 6500K 1800 Lm ● **cód. 147914**
SLIM 36W 6500K 3600 Lm ○ **cód. 147543**
SLIM 36W 6500K 3600 Lm ● **cód. 147917**
SLIM 36W 6500K 3600 Lm ● **cód. 147915**

L:1235 W:44 H:127 mm



INCLUYE 2 TUBOS LED

Material Policarbonato + Acero + Poliestireno
2x18W 6500K 2900 Lm **cód. 145793**

Undercabinet Adosado LED

L:568 W:36 H:22 mm
3 LUCES



Material Policarbonato
9W 3000K-4000K-6500K 720 Lm **cód. 147178**

✓ 3 PASOS PARA SELECCIÓN DE LUZ CALIDA, FRÍA O NEUTRA



✓ OPCIÓN PARA UNIR EN LÍNEA

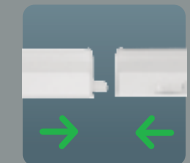

✓ INCLUYE ENCHUFE PLANO



Proyectores LED para Riel

Ø:60 H:125 mm



Material Poliamida + Policarbonato
 10W COB 3000K 1040 Lm cód. 147537
 10W COB 3000K 1040 Lm cód. 147539

Ø:80 H:185 mm

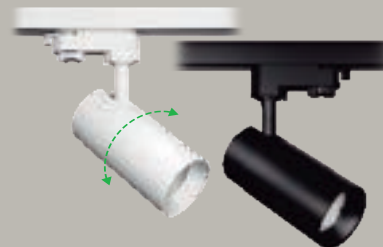

Material Poliamida + Policarbonato
 20W COB 3000K 2100 Lm cód. 147538
 20W COB 3000K 2100 Lm cód. 147540
 20W COB 4000K 2250 Lm cód. 147541

Ø:80 H:125 mm



Material Aluminio + Policarbonato
 30W 3000K-4000K-6000K 3000 Lm cód. 147821

CON SWITCH SELECTOR DE LUZ CÁLIDA, NEUTRA O FRÍA

Ø:69 H:142 mm



Material Aluminio
 10W 3000K 900 Lm cód. 146389
 10W 3000K 900 Lm cód. 146390

Ø:59 H:154 mm



Material Aluminio + Policarbonato
 1xGU10 3000K 800 Lm cód. 147494
 1xGU10 3000K 800 Lm cód. 147495
 1xGU10 3000K 800 Lm cód. 147496

INCLUYEN FOCO GU10 LED 8W

Ø:56 H:275 mm



Material Aluminio
 10W 3000K 800 Lm cód. 145041

Rieles adosados para Proyectores

1 METRO



2 METROS



Material Aluminio
 1 METRO cód. 146885
 1 METRO cód. 146884
 2 METROS cód. 146882
 2 METROS cód. 146867

RIELES DE UNA LÍNEA (1L+N)



Línea Magnet LED

Lineales

L:300 W:22 H:43 mm

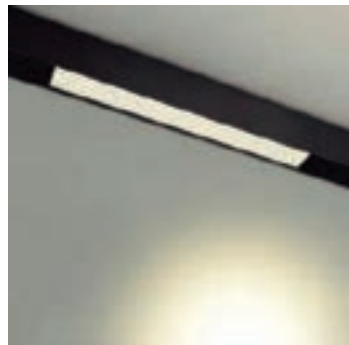

Material Aluminio + ABS
12W 3000K 300 Lm **cód. 147593**

L:600 W:22 H:43 mm

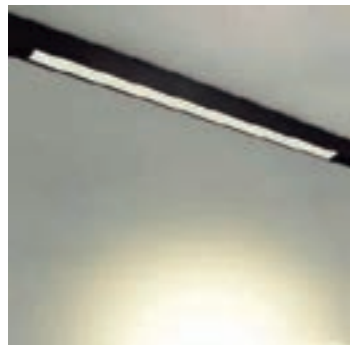

Material Aluminio + ABS
24W 3000K 600 Lm **cód. 147594**

Lineal Dirigible

L:230 W:22 H:85 mm

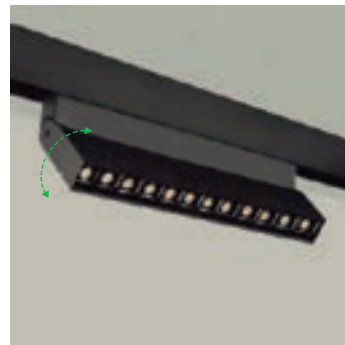

Material Aluminio + Polipropileno
12W 3000K 350 Lm **cód. 147595**

Proyector

Ø:70 L:116 mm 



Material Aluminio
20W 3000K 480 Lm **cód. 147596**

Colgante

Ø:50 L:150 mm | Altura regulable hasta 1400 mm



Material Aluminio
6W 3000K 180 Lm **cód. 147597**

Rieles Magnet Adosados

1 metro



Material Aluminio
cód. 147604

2 metros



Material Aluminio
cód. 147605

Conectores Magnet

Lineal

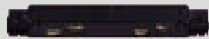

Material Policarbonato
cód. 147598

Flexible



Material Policarbonato
cód. 147599

Ángulos Magnet

De techo



Material Aluminio
cód. 147600

De techo/pared



Material Aluminio
cód. 147601

Drivers Magnet

L:255 W:23 H:44 mm



Potencia Máx. 100W
Material Policarbonato
Entrada 100-240V/50-60Hz
Salida 48VDC
Corriente Máx. 2.1A
Vida útil 30,000 horas
cód. 147602

L:255 W:23 H:44 mm



Potencia Máx. 200W
Material Policarbonato
Entrada 100-240V/50-60Hz
Salida 48VDC
Corriente Máx. 4.2A
Vida útil 30,000 horas
cód. 147603

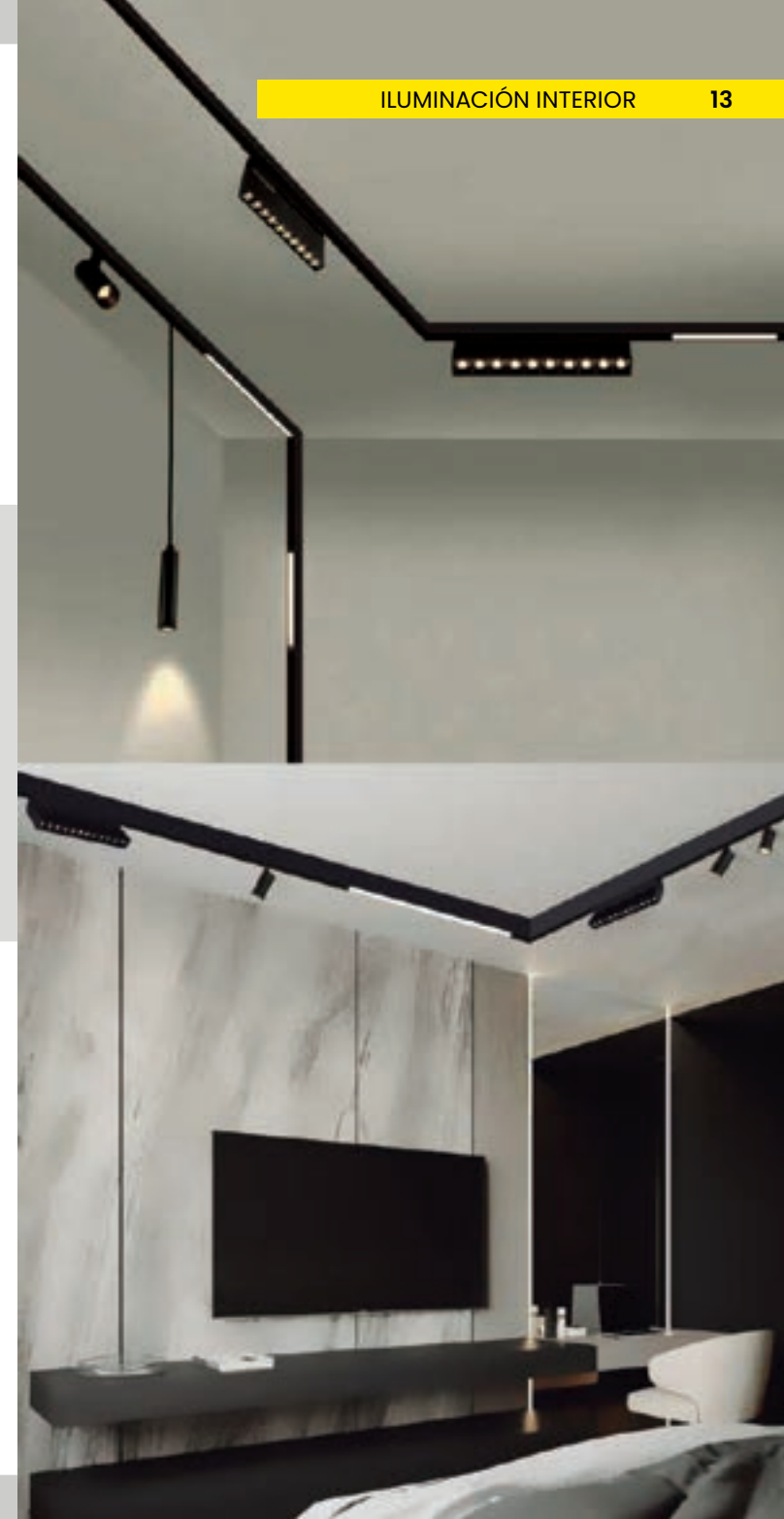

Lineal Block LED

Adosado o Suspendido & Conectores

L:1131 W:50 H:75 mm | Altura regulable hasta 1400 mm

3 CCT | PF >0.9 | 50 MIL HORAS

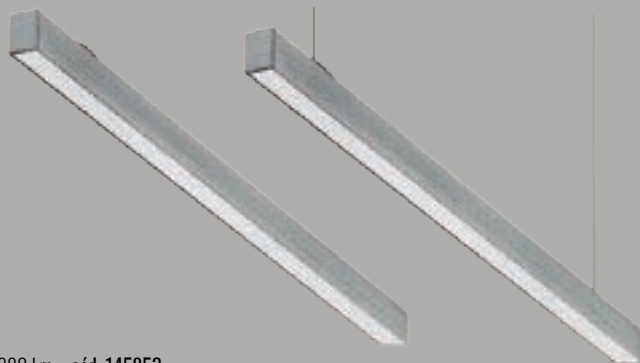

Material Aluminio + Policarbonato
32W 3000K-4000K-6000K 2880 Lm cód. 145853

✓ LUZ DIRECTA. INSTALACIÓN ADOSADA O SUSENDIDA

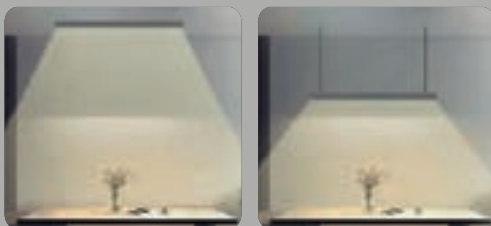

✓ DIFUSOR CON UGR (ANTI DESLUMBRAMIENTO)

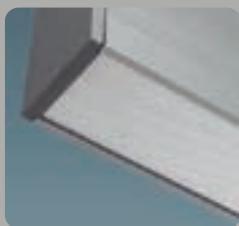

✓ CON SWITCH SELECTOR DE LUZ CÁLIDA, NEUTRA O FRÍA

Conectores para crear figuras según el espacio

EN I
cód. 145856



ANGULAR
cód. 145855



ANGULAR 3
cód. 145859



ANGULAR 4
cód. 145860



Lineales Suspendidos LED

L:1217 W:75 H:64 mm | Altura regulable hasta 1400 mm

PF >0.9 | 100LM/W | 50 MIL HORAS



Material Aluminio
 40W 4000K 4000 Lm ● cód. 145705
 40W 4000K 4000 Lm ● cód. 145302

✓ CON DIFUSOR

✓ INSTALACIÓN ADOSADA O Suspendida (EL KIT DE SUSPENSIÓN ESTÁ INCLUIDO)



✓ OPCIÓN PARA UNIR EN LÍNEA USANDO UN CONECTOR INVISIBLE

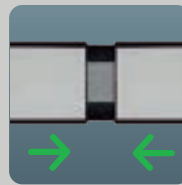

CONECTOR EN "I" cód. 145421



Lineal Empotrado LED

L:1231 W:51 H:84 mm | Perforación: 1215x68 mm

PF >0.9 | 100LM/W | 50 MIL HORAS



Material Aluminio
 40W 4000K 4000 Lm cód. 145270



✓ UNIÓN INVISIBLE EN LÍNEA

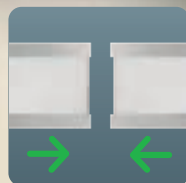

Lineal Recesado LED

L:379 W:48 H:61 mm | Perforación: 350x70 mm

30°



Material Aluminio + Plástico
 20W 3000K 1060 Lm cód. 147202



✓ LENTES ÓPTICAS CON ÁNGULO DE APERTURA DE LUZ DE 30°



Bañador de Pared LED

L:500 W:43 H:18 mm | Perforación: 502x38 mm

50 MIL HORAS



Material Aluminio + Policarbonato
 15W 3000K 1200 Lm cód. 145048

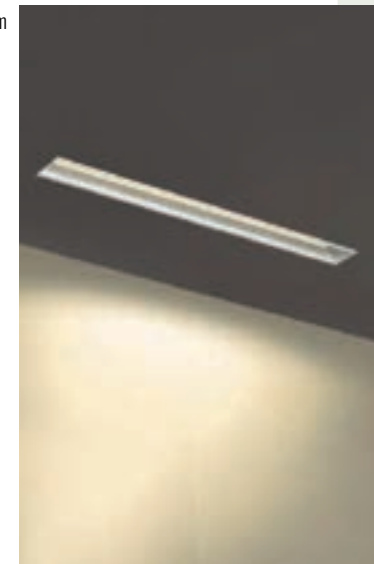

Apliques de Interior LED

L:80 W:260 H:200 mm



Material Aluminio + Metal + Acrílico

3W 3000K 184 Lm cód. 147371
3W 3000K 184 Lm cód. 147372

SWITCH ON/OFF

L:63 W:145 H:150 mm



Material Metal + Acrílico

7W 3000K 490 Lm cód. 147755
7W 3000K 490 Lm cód. 147533

SWITCH ON/OFF

L:60 W:110 H:150 mm



Material Metal + Aluminio

2W 3000K 140 Lm cód. 147754
2W 3000K 140 Lm cód. 147534

SWITCH ON/OFF

L:250 W:100 H:95 mm
L:435 W:100 H:95 mm



Material Aluminio + Metal

6W 3000K 450 Lm cód. 145170
12W 3000K 900 Lm cód. 145171

L:280 W:80 H:85 mm



Material Metal + Acrílico

10W 3000K 549 Lm cód. 147375

L:120 W:141 H:120 mm
L:288 W:141 H:120 mm
L:308 W:141 H:120 mm

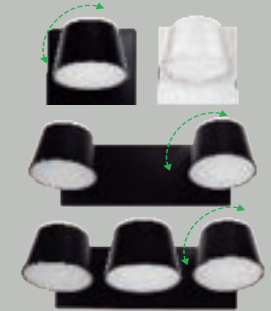

Material Plástico

7W 3000K 420 Lm cód. 146739
7W 3000K 420 Lm cód. 146740
2x7W 3000K 840 Lm cód. 146741
3x3W 3000K 1260 Lm cód. 146742

Ø:120 H:47 mm
Ø:222 H:47 mm

CCT IP65 100LM/W

LUZ INDIRECTA
 USO INTERIOR Y EXTERIOR

Material Policarbonato

9W 3000K-4000K-6000K 900 Lm cód. 147804
9W 3000K-4000K-6000K 900 Lm cód. 147490
15W 3000K-4000K-6000K 1500 Lm cód. 147805
15W 3000K-4000K-6000K 1500 Lm cód. 147491

CON SWITCH SELECTOR DE LUZ CÁLIDA, NEUTRA O FRÍA

L:180 W:90 H:25 mm



Material Metal + Aluminio + Vidrio

10W 3000K 968 Lm cód. 147373

L:604 W:104 H:60 mm

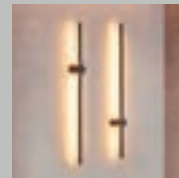

Material Aluminio + Policarbonato

12W 3000K 775 Lm cód. 146983

LUZ INDIRECTA

L:900 W:60 H:130 mm
L:600 W:50 H:100 mm



Material Aluminio + Metal + Acrílico

30W 3000K 2550 Lm cód. 145173

Material Policarbonato

20W 3000K 1454 Lm cód. 147374

L:285 W:90 H:123 mm



DETALLE DE LUZ FRONTAL

Material Aluminio

8W 3000K 480 Lm cód. 145658

Apliques de Interior No Integrados

Ø Base:86 W:120 mm
L:300 W:86 H:100 mm

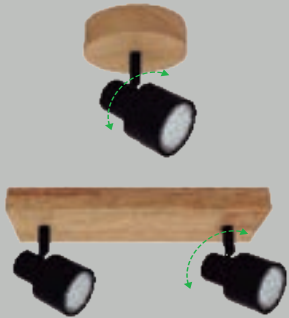

Material Metal + Madera
1xGU10 MÁX 50W cód. 147367
2xGU10 MÁX 50W cód. 147368

L Base:149 W:204 H:217 mm



Material Metal + Vidrio
1xE27 MÁX 25W cód. 147475

Ø Base:100 L:185 W:180 H:430 mm



Material Metal + Vidrio
1xE27 MÁX 40W cód. 146524

Ø Base:100 L:120 W:230 H:230 mm



Material Metal + Vidrio
1xE27 MÁX 40W cód. 146523

Ø Base:120 L:130 W:200 H:250 mm



Material Metal + Vidrio
1xE27 MÁX 40W cód. 147091

Ø Base:120 W:210 H:316 mm



Material Metal + Ratán
1xE27 MÁX 40W cód. 147473

SWITCH ON/OFF

Ø:110 W:132 H:110 mm

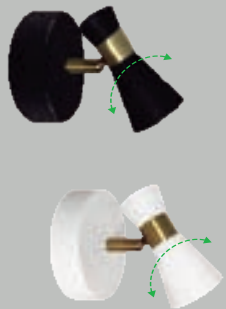

Material Metal
1xGU10 MÁX 35W ● cód. 147437
1xGU10 MÁX 35W ○ cód. 147438

Ø Base:110 L:327 H:137 mm

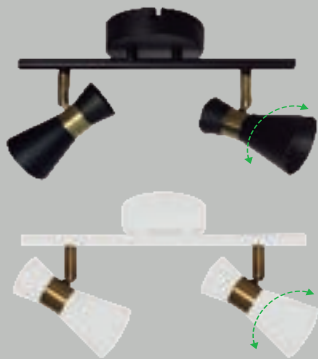

Material Metal
2xGU10 MÁX 35W ● cód. 147439
2xGU10 MÁX 35W ○ cód. 147440

Ø Base:110 W:106 H:230 mm



Material Metal
2xGU10 MÁX 35W cód. 147442

Ø Base:110 L:132 H:147 mm



Material Metal
1xE27 MÁX 60W cód. 147443

Ø Base:110 L:350 H:170 mm

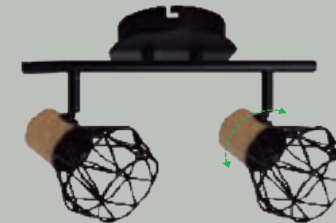

Material Metal
2xE27 MÁX 60W cód. 147444

Ø Base:110 W:285 H:237 mm



Material Metal
1xE27 MÁX 60W cód. 147445

Plafones LED

Ø:125 H:45 mm
 Ø:200 H:50 mm
 Ø:280 H:65 mm
 Ø:360 H:75 mm



Material Metal + ABS

12W 6000K 1080 Lm **cód. 145588**
 24W 6000K 2160 Lm **cód. 145589**
 36W 3000K 3160 Lm **cód. 145818**
 48W 6000K 4320 Lm **cód. 145591**

Ø:380 H:60 mm



Material Plástico

40W 3000K 2800 Lm (SIN MARCO) **cód. 147076**
 40W 6000K 2800 Lm (SIN MARCO) **cód. 147075**
 40W 3000K 2800 Lm (CON MARCO) **cód. 147078**
 40W 6000K 2800 Lm (CON MARCO) **cód. 147077**

Ø:380 H:60 mm



Material Plástico

40W 3000K 2800 Lm ● **cód. 147082**
 40W 6000K 2800 Lm ● **cód. 147081**
 40W 3000K 2800 Lm ● **cód. 147080**
 40W 6000K 2800 Lm ● **cód. 147079**

Ø:400 H:96 mm



Material Aluminio + Acero + Acrílico

45W 3000K 2279 Lm **cód. 146729**

Ø:400 H:60 mm



Material Metal + Aluminio + Acrílico

36W 3000K 2160 Lm **cód. 147083**

Ø:400 H:90 mm



Material Acero + Policarbonato

37W 3000K 2590 Lm ● **cód. 147341**
 37W 3000K 2590 Lm ● **cód. 147342**

Ø:455 H:150 mm



Material ABS + Acero + Metal

32W 3000K 2720 Lm ○ **cód. 146383**
 32W 3000K 2720 Lm ● **cód. 146384**

Ø:455 H:170 mm



Material ABS + Acrílico + Metal

36W 3000K 2520 Lm ● **cód. 146955**
 36W 3000K 2520 Lm ○ **cód. 146953**

LIGHTTECH

Plafón ventilador Smart

Ø:550 H:220 mm



Material Poliestireno + Acrílico

36W 30K-40K-65K 3300 Lm **cód. 147751**

- ✓ VENTILADOR DE 6 VELOCIDADES
- ✓ CONTROL POR APP APPLIANCE SMART
- ✓ CON SWITCH SELECTOR DE LUZ CÁLIDA, NEUTRA O FRÍA

Ø:805 H:160 mm
 Ø:805 H:175 mm

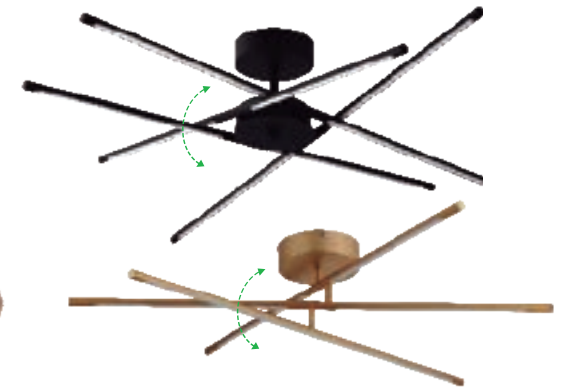

Material Metal + Acrílico

40W 3000K 3200 Lm ● **cód. 147526**
 32W 3000K 2560 Lm ● **cód. 147525**

Plafón ventilador Smart

Ø:500 H:140 mm



3 LUCES



DIM



Material Metal + Acrílico

30W 30K-40K-65K 2500 Lm ○ cód. 147752
 30W 30K-40K-65K 2500 Lm ● cód. 147753

✓ VENTILADOR DE 6 VELOCIDADES

✓ CONTROL POR APP APPLIANCE SMART

L:500 W:500 H:90 mm



Material Acero + Policarbonato

63W 4000K 4410 Lm cód. 147343

Plafones Herméticos LED IP65

Ø:165 H:58 mm
 Ø:220 H:66 mm



IP65



Material Aluminio + Policarbonato

15W 3000K 1400 Lm cód. 147411
 15W 6000K 1480 Lm cód. 147357
 20W 3000K 1800 Lm cód. 147186
 20W 6000K 1800 Lm cód. 147187

20W 6000K 1800 Lm cód. 145367

✓ SENSOR DE MOVIMIENTO



Ø:165 H:58 mm
 Ø:220 H:66 mm



IP65

PF >0.9



Material Aluminio + Policarbonato

15W 3000K 1400 Lm cód. 147836
 15W 6000K 1480 Lm cód. 147875
 20W 6000K 1800 Lm cód. 147876

Ø:280 H:50 mm



CCT



IP65



115LM/W

50 MIL HORAS



Material Policarbonato

18W 3000K-4000K-5700K 2070 Lm cód. 146726

✓ CON SWITCH SELECTOR DE LUZ CÁLIDA, NEUTRA O FRÍA

Ø:300 H:78 mm



IP65



Material Aluminio + Policarbonato

30W 6000K 2500 Lm ● cód. 144697
 30W 6000K 2700 Lm ● cód. 145651

Ø:300 H:78 mm



CCT



IP65

PF >0.9



Material Aluminio + Policarbonato

30W 3000K-4000K-6000K 2700 Lm cód. 147812

✓ CON SWITCH SELECTOR DE LUZ CÁLIDA, NEUTRA O FRÍA

Ø:226 H:72 mm



IP65



Material Aluminio + Policarbonato

20W 6000K 1800 Lm ● cód. 145417
 20W 3000K 1750 Lm ● cód. 145649
 20W 6000K 1800 Lm ● cód. 145648
 20W 6000K 1800 Lm ● cód. 145650

Ø:226 H:72 mm



CCT



IP65

PF >0.9



Material Aluminio + Policarbonato

20W 3000K-4000K-6000K 1800 Lm ● cód. 147811
 20W 3000K-4000K-6000K 1800 Lm ● cód. 147872
 20W 3000K-4000K-6000K 1800 Lm ● cód. 147810

✓ CON SWITCH SELECTOR DE LUZ CÁLIDA, NEUTRA O FRÍA



Apliques de Exterior

L:210 W:48 H:80 mm



L:80 W:75 H:63 mm
L:144 W:80 H:63 mm



L:180 Ø:90 H:105 mm



L:183 Ø:95 H:108 mm



L:160 W:160 H:11 mm



Material Acrílico + Polipropileno
8W 3000K 800 Lm **cód. 147483**

Material Policarbonato
6W 3000K 600 Lm **cód. 147492**
12W 3000K 1200 Lm **cód. 147493**

Material Aluminio + Vidrio
10W COB 3000K 400 Lm **cód. 147115**

Material Aluminio + Policarbonato
10W 3000K 400 Lm **cód. 147116**

Material Policarbonato + Polipropileno
15W 30K-40K-60K 1200 Lm **cód. 147813**

✓ CON SWITCH SELECTOR DE LUZ CÁLIDA, NEUTRA O FRÍA

Apliques LED con ángulos de apertura graduables

L:100 W:100 H:100 mm



L:120 W:120 H:29 mm



✓ PESTAÑAS CON ÁNGULOS GRADUABLES HASTA 92°



Material Aluminio
6W 3000K 360 Lm ○ **cód. 147740**
6W 3000K 360 Lm ● **cód. 147586**

Material ABS
4W 3000K 180 Lm ○ **cód. 147756**
4W 3000K 180 Lm ● **cód. 147741**



L:230 W:90 H:100 mm



L:250 W:105 H:110 mm



Material Policarbonato
12W 3000K 580 Lm **cód. 145032**

Material Aluminio + Vidrio
20W 3000K 1000 Lm **cód. 147113**

L:268 W:132 H:87 mm **3** CCT | | IP65 | **PF >0.9**

Material Policarbonato
20W 30K-40K-60K 1800 Lm **cód. 147832**

CON SWITCH SELECTOR DE LUZ CÁLIDA, NEUTRA O FRÍA

L:150 W:72 H:95 mm | IP65

Material Policarbonato
2xGU10 **cód. 146504**

USO CON FOCO LED

L:250 Ø:90 H:148 mm | IP44

Material Aluminio + Vidrio
1xE27 MÁX 35W **cód. 147114**

L:205 W:120 H:100 mm | IP54

Material Policarbonato + Vidrio
1xE27 MÁX 50W ○ **cód. 145761**
1xE27 MÁX 50W ● **cód. 145760**

NO INCLUYEN FOCO

L:300 W:150 H:86 mm | IP65 | SENSOR | **PF >0.9**

Material Policarbonato
20W 6000K 1500 Lm **cód. 147300**

L:212 W:56 H:113 mm | IP65 | **PF >0.9**
L:270 W:71 H:146 mm | IP65

- Material Policarbonato
- 15W **PF 0.5** 3000K 1350 Lm ○ **cód. 147454**
 - 15W **PF 0.5** 6000K 1350 Lm ○ **cód. 147455**
 - 20W **PF 0.5** 3000K 1800 Lm ○ **cód. 147190**
 - 20W **PF 0.5** 6000K 1800 Lm ○ **cód. 147191**
 - 15W **PF 0.9** 3000K 1350 Lm ○ **cód. 147837**
 - 15W **PF 0.9** 6000K 1350 Lm ○ **cód. 147784**
 - 20W **PF 0.9** 3000K 1800 Lm ○ **cód. 147877**
 - 20W **PF 0.9** 6000K 1800 Lm ○ **cód. 147786**
 - 20W **PF 0.9** 6000K 1800 Lm ● **cód. 147909**

L:271 W:76 H:146 mm | IP65

- Material Policarbonato
- 20W 3000K 1750 Lm **cód. 144806**
 - 20W 6000K 1800 Lm **cód. 144807**

L:270 W:140 H:94 mm | IP65 | **PF >0.9**

- Material Policarbonato
- 30W **PF 0.5** 3000K 2600 Lm ○ **cód. 145137**
 - 30W **PF 0.5** 6000K 2700 Lm ○ **cód. 145136**
 - 30W **PF 0.5** 3000K 2600 Lm ● **cód. 145135**
 - 30W **PF 0.5** 6000K 2700 Lm ● **cód. 145134**
 - 30W **PF 0.9** 3000K 2700 Lm ○ **cód. 147830**
 - 30W **PF 0.9** 6000K 2700 Lm ○ **cód. 147831**
 - 30W **PF 0.9** 3000K 2700 Lm ● **cód. 147829**
 - 30W **PF 0.9** 6000K 2700 Lm ● **cód. 147830**

L:240 Ø:78 H:99 mm **3** CCT | | IP65

Material Policarbonato

- 18W 3000K-4000K-6000K 1600 Lm ○ **cód. 147500**
- 18W 3000K-4000K-6000K 1600 Lm ● **cód. 147499**

SWITCH SELECTOR DE LUZ CÁLIDA, NEUTRA O FRÍA

L:155W: 120 L:83 mm SOLAR | | IP54

Material Policarbonato
0.4W 3000K 50 Lm **cód. 147418**

- CARGA: 6 HORAS**
- AUTONOMÍA: 10 HORAS**
- SIN INSTALACIÓN ELÉCTRICA**
- CARGA DE DÍA / ILUMINA DE NOCHE**



Luces Guía Empotradas LED

L:230 W:80 H: 57 mm

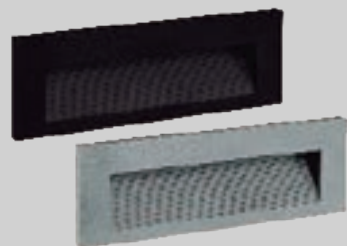

Material Policarbonato

6W 30K-40K-60K 300 Lm ● cód. 147817
6W 30K-40K-60K 300 Lm ● cód. 147818

L:123 W:53 H:61 mm



Material Aluminio + Policarbonato

2W 3000K 90 Lm cód. 145638
2W 3000K 90 Lm cód. 145704

✓ SWITCH SELECTOR DE LUZ CÁLIDA, NEUTRA O FRÍA

LIGHTTECH

Luces Guía Adosadas LED

Ø:110 H:15 mm



Material Policarbonato

3W 3000K 200 Lm ● cód. 147833
3W 3000K 200 Lm ○ cód. 147834



L:84 W:84 H:43 mm



Material Aluminio

3W 3000K 90 Lm cód. 145034

L:90 W:90 H:71 mm



Material Aluminio

3W 3000K 135 Lm cód. 145639

L:84 W:84 H:43 mm



Material Aluminio

3W 3000K 60 Lm cód. 147358

L:80 W:80 H:61 mm



Material Aluminio + Policarbonato

2W 3000K 90 Lm cód. 145324

L:230 W:80 H:25 mm

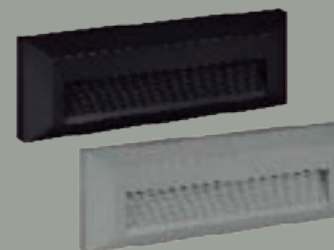

Material Policarbonato

6W 30K-40K-60K 300 Lm ● cód. 147819
6W 30K-40K-60K 300 Lm ● cód. 147820

✓ SWITCH SELECTOR DE LUZ CÁLIDA, NEUTRA O FRÍA

L:110 W:90 H:13 mm



Material Policarbonato

4W 30K-40K-60K 250 Lm cód. 147835

✓ SWITCH SELECTOR DE LUZ CÁLIDA, NEUTRA O FRÍA

Estacas

Estaca:155 Ø:92 mm  IP65



Material Aluminio
1xGU10 MÁX 50W **cód. 16780**

L:120 W:145 Ø:56 mm  IP65



Material ABS
6W 3000K 480 Lm **cód. 145355**

 **USO EN PARED O TECHO**

Estaca:100 L:100 W:90 mm  IP65



Material ABS
8W 3000K 525 Lm **cód. 146715**

 **USO EN PARED O COMO ESTACA**

Estaca:105 Ø:55 mm  IP65



Material Policarbonato
6W 3000K 540 Lm **cód. 146716**

Estaca:170 Ø:74 mm  IP65



Material Policarbonato
7W 3000K 580 Lm **cód. 144737**

Estaca:178 Ø:57 mm  IP65



Material Aluminio + ABS
10W COB 3000K 800 Lm **cód. 147544**

Estaca:178 Ø:57 mm  IP65  RGB  DIM





Material Aluminio + ABS
10W RGB 600 Lm **cód. 147545**

 **INCLUYE CONTROL REMOTO**

Estacas LED solares

 **SIN INSTALACIÓN ELÉCTRICA**

 **CARGA DE DÍA / ILUMINA DE NOCHE**

Estaca:100 Ø:55 mm  SOLAR  IP54



Material Plástico
0.2 3000K 21 Lm **cód. 147423**

 **CARGA: 8 HORAS**

 **AUTONOMÍA: 10 HORAS**

Estaca:150 L:100 mm  SOLAR  IP65





Material Policarbonato
1.8W 3000K -Luz Verde 200 Lm **cód. 147814**

 **CARGA: 8 HORAS**

 **AUTONOMÍA: 4 HORAS**

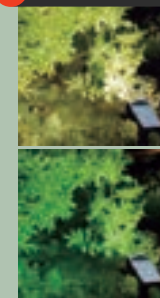
 **SWITCH 2 LUCES**





Estaca:100 Ø:90 mm  SOLAR  IP54



Material Acero inoxidable + Plástico
0.3W 3000K 7 Lm **cód. 147420**

 **CARGA: 10 HORAS**

 **AUTONOMÍA: 10 HORAS**

Estaca:100 Ø:75mm  SOLAR  IP54
Estaca:100 Ø:156 mm



Material Plástico
0.2 3000K 2 Lm **cód. 147421**
0.6 3000K 7 Lm **cód. 147422**

 **CARGA: 7 HORAS**

 **AUTONOMÍA: 10 HORAS**



Guirnalda LED

Largo: 10 metros



Material PVC + Cable de cobre
20x E27 MÁX 20W **cód. 147618**

- ✓ 10 METROS PARA 20 FOCOS (NO INCLUIDOS)
- ✓ CONEXIÓN DIRECTA CON ENCHUFE PLANO
- ✓ UNE HASTA 5 GUIRNALDAS (MÁX 50 METROS)



Packs x 20 Focos LED ST14 E27



Material	Policarbonato	
1W Clear	3000K 45 Lm	cód. 147857
1W Ambar	3000K 45 Lm	cód. 147856

Postes

Ø: 135 H: 570 mm



Material Aluminio
1x E27 MÁX 35W **cód. 147119**

L: 83 H: 615 mm



Material ABS + Vidrio
10W 3000K 600 Lm **cód. 147546**



Embutidos de Piso

Ø: 120 H: 70 mm
Perforación: 98 mm



Material Aluminio
3W 3000K 240 Lm **cód. 145758**

Ø: 80 H: 74 mm
Perforación: 73 mm



Material Aluminio
5W 3000K 275 Lm **cód. 147180**

Ø: 100 H: 145 mm
Perforación: 95 mm



Material Aluminio
7W COB 3000K 560 Lm **cód. 145827**

Ø: 110 H: 110 mm
Perforación: 95 mm



Material Acero + ABS
1x GU10 MÁX 50W **cód. 147069**

- ✓ NO INCLUYE FOCO
- ✓ USO CON FOCO LED

Ø: 180 H: 180 mm
Perforación: 176 mm



PF > 0.9

100LM/W

50 MIL HORAS



Material Aluminio
18W 3000K 1800 Lm **cód. 147592**

- ✓ ÁNGULO INTERIOR DIRIGIBLE DE 0 A 15° HACIA AMBOS LADOS



Luminarias Herméticas LED IP65

L:1200 W:100 H:62 mm



Material ABS - Policarbonato
48W 6000K 4000 Lm **cód. 145790**

L:1275 W:114 H:56 mm



Material ABS - Policarbonato
2x18W 4000K 3240 Lm **cód. 147143**
2x18W 6500K 3240 Lm **cód. 147144**

L:1200 W:66 H:55 mm



Material ABS - Policarbonato
36W 6500K 3000 Lm **cód. 146336**

L:1240 W:51 H:44 mm



Material ABS - Policarbonato
36W 4000K 4320 Lm **cód. 147159**
36W 6500K 4320 Lm **cód. 147160**

L:600 W:70 H:56 mm / L:1200 W:70 H:56 mm



Material ABS - Policarbonato
20W 6500K 2400 Lm **cód. 147763**
40W 4000K 4800 Lm **cód. 147145**
40W 6500K 4800 Lm **cód. 147146**



Campanas High Bay LED

Ø:358 H:32 mm



Material Aluminio - Policarbonato
200W 6500K 20000 Lm **cód. 147723**

Ø:288.8 H:197 mm / Ø:332.7 H:202 mm



Material Aluminio - Policarbonato
150W 6000K 22500 Lm **cód. 147127**
200W 6000K 30000 Lm **cód. 147128**

Ø:299 H:184 mm



Material Aluminio - Policarbonato
100W-150W-200W 30K-40K-60K 15000-22500-30000 Lm **cód. 147801**

SELECCIÓN DE POTENCIAS Y TEMPERATURAS

100W	150W	200W
6000K	4000K	3000K

✓ CON SWITCH SELECTOR DE LUZ CÁLIDA, NEUTRA O FRÍA

✓ KIT DE EMERGENCIA PARA CAMPANAS HIGH BAY **cód. 147129**

Urbana LED

L:380 W:156 H:70 mm



Material Aluminio
60W 4000K 6000 Lm **cód. 145900**

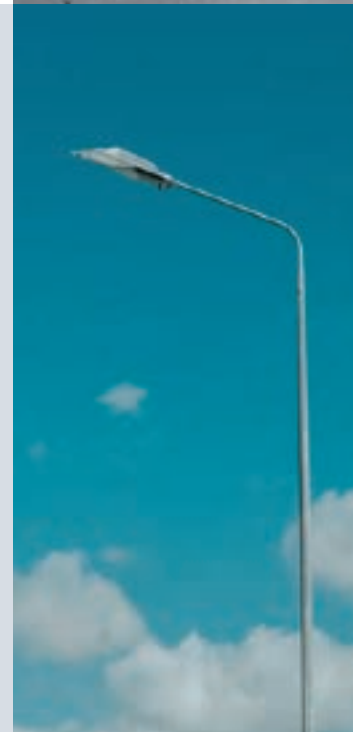



Reflectores LED

L:136 W:23 H:97 mm
L:163 W:24 H:121 mm

IP65 PF >0.9



Material Aluminio + Vidrio
30W 6500K 2700 Lm **cód. 147182**
50W 3000K 4500 Lm **cód. 147183**

L:164 W:79 H:167 mm
L:183 W:79 H:188 mm

IP65 SENSOR PF >0.9



Material Aluminio + Vidrio
30W 6500K 2850 Lm **cód. 147508**
50W 6500K 5000 Lm **cód. 147509**

L:231 W:31 H:160 mm

IP65 100LM/W



Material Aluminio + Acrílico
50W 6000K 5000 Lm **cód. 145311**

L:183 W:32 H:205 mm
L:217 W:33 H:244 mm
L:284 W:33 H:318 mm

IP65 PF >0.9



Material Aluminio + Vidrio
50W 6500K 4500 Lm **cód. 146973**
100W 3000K 9000 Lm **cód. 147764**
100W 6500K 9000 Lm **cód. 146974**
200W 6500K 18000 Lm **cód. 146975**

L:253 W:31 H:284 mm
L:272 W:32 H:309 mm
L:297 W:32 H:338 mm
L:400 W:41 H:494 mm

IP65 PF >0.9 110LM/W 50 MIL HORAS



Material Aluminio + Policarbonato
100W 6500K 11000 Lm **cód. 146936**
150W 6500K 16500 Lm **cód. 146948**
200W 6500K 22000 Lm **cód. 146937**
400W 6500K 44000 Lm **cód. 146949**

RESISTENTE PANTALLA DE POLICARBONATO

Reflectores LED Solares

L:300 W:86 H:70 mm

SOLAR SENSOR IP65 DIM 112LM/W



Material Policarbonato
4W 6500K 450 Lm **cód. 147419**

- ✓ INCLUYE CONTROL REMOTO
- ✓ CARGA: 6 HRS | AUTONOMÍA: 10 HRS

L:143 W:97 H:44 mm
L:194 W:97 H:44 mm

SOLAR CCT SENSOR IP65 DIM 120LM/W



SELECCIÓN DE INTENSIDAD Y TEMPERATURA DE LUZ

Material ABS + Vidrio
8W 30K-40K-65K 1000 Lm **cód. 147807**
10W 30K-40K-65K 1200 Lm **cód. 147808**

- ✓ LUZ CÁLIDA, NEUTRA O FRÍA
- ✓ CARGA: 6-8 HRS | AUTONOMÍA: 75 MIN

SIN INSTALACIÓN ELÉCTRICA

CARGA DE DÍA / ILUMINA DE NOCHE

Reflectores LED con Trípode

Reflectores: L:175 H:130 mm  IP65 | **PF >0.9**

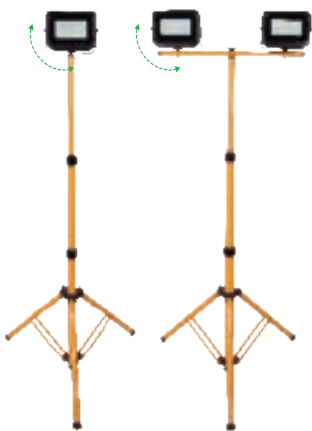

 **ALTURA REGULABLE HASTA 160 CM**



 **APERTURA REGULABLE HASTA 78 CM**



Material Aluminio + Vidrio
45W 6500K 4050 Lm **cód. 147504**
2x45W 6500K 8100 Lm **cód. 147505**

 **CABLE DE 3 METROS CON ENCHUFE TIPO B (MONOFÁSICO + TIERRA)**



Luminarias de Emergencia y Salida LED

L:260 W:59 H:105 mm **PF >0.9** | **50 MIL HORAS**



Material ABS + Poliestireno
2x1.2W 6500K 180 Lm **cód. 147800**

 **AUTONOMÍA: 3 HORAS**

L:277 W:69 H:114 mm **PF >0.9**



Material Polipropileno + Poliestireno
2x1.2W 6500K 150 Lm **cód. 147738**

 **AUTONOMÍA: 3 HORAS**

L:280 W:113 H:298 mm **PF >0.9**



Material Polipropileno + Poliestireno
2x2W 6500K 280 Lm **cód. 147809**

 **AUTONOMÍA: 8 HORAS**

L:277 W:69 H:114 mm **PF >0.9**



Material Polipropileno + Poliestireno
2x2W 6500K 200 Lm **cód. 147791**

 **AUTONOMÍA: 8 HORAS**

Ø1:141 mm  100LM/W | **50 MIL HORAS**



Material ABS
5W 7500K 500 Lm **cód. 146127**

 **EMPOTRADO TIPO SPOT**

 **AUTONOMÍA: 3 HORAS**

L:255.5 W:90 H:50 mm **50 MIL HORAS** | **PF >0.9**



Material ABS
3W 7500K 90 Lm **cód. 146126**

 **3W PF 0.9 7500K 90 Lm **cód. 147860****

 **AUTONOMÍA: 3 HORAS**

L:351 W:117 H:78 mm  IP65 | **50 MIL HORAS** | **PF >0.9**



INCLUYE STICKERS DE EVACUACIÓN



Material ABS + Policarbonato
3W 7500K 128 Lm **cód. 147859**

 **AUTONOMÍA: 3 HORAS**

 **2 USOS: • LUZ DE EMERGENCIA • LUZ PERMANENTE**

L:260 W:226 H:27 mm **50 MIL HORAS**



INCLUYE STICKERS DE SEÑALIZACIÓN



Material ABS
2W 7500K 6 Lm **cód. 147203**

 **AUTONOMÍA: 1.5 HORAS**

Bombillería LED

GU10 LED

Ø:50 H:56 mm
60°



Material PBT + Policarbonato
6W 3000K 520 Lm **cód. 144063**
6W 6000K 570 Lm **cód. 144064**
8W 3000K 580 Lm **cód. 143708**
8W 4000K 600 Lm **cód. 145419**
8W 6000K 728 Lm **cód. 143296**

Ø:50 H:56 mm
60°
100LM/W



Material PBT + Policarbonato
8W Premium 3000K 850 Lm **cód. 146166**
8W Premium 6000K 900 Lm **cód. 146167**

Ø:50 H:56 mm
DIM
60°



Material PBT + Policarbonato
8W COB 3000K 580 Lm **cód. 145383**

Ø:50 H:56 mm
PF >0.9
60°



Material PBT + Policarbonato
8W 3000K 580 Lm **cód. 147303**

Ø:50 H:54 mm
DIM
RGB
60°



Material PBT + Policarbonato
5W 2700-6500K 400 Lm **cód. 146634**

Ø:50 H:56 mm
24°

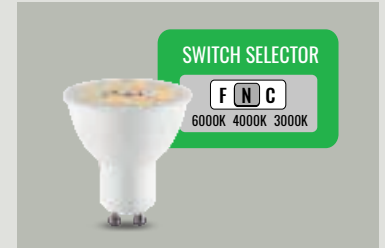

Material Poliamida + Policarbonato
6W 3000K-4000K-6000K 500 Lm **cód. 147765**

✓ RGB - 16 MILLONES DE COLORES

✓ FOCO SMART CON APP **tuya®**

✓ CON SWITCH SELECTOR DE LUZ CÁLIDA, NEUTRA O FRÍA

GU5.3 LED

Ø:50 H:48 mm
60°



Material PBT + Policarbonato
4W 3000K 300 Lm **cód. 144619**
4W 6000K 340 Lm **cód. 144620**
6W 3000K 430 Lm **cód. 143635**
6W 6000K 450 Lm **cód. 143479**
8W 3000K 560 Lm **cód. 143480**
8W 6000K 580 Lm **cód. 143481**

G9 LED

Ø:16 H:52 mm
320°



Material Policarbonato
3W 2700K 260 Lm **cód. 143297**
3W 6000K 280 Lm **cód. 143298**

Ø:19 H:58 mm
320°



Material Policarbonato
4.5W 3000K 550 Lm **cód. 146500**

T26 E14 LED

Ø:25 H:59 mm
280°



Material Plástico + Policarbonato
1.5W 6500K 135 Lm **cód. 147510**

G45 E27 LED

Ø:45 H:86 mm
150°



Material Aluminio + Policarbonato
7W 3000K 560 Lm **cód. 146501**
7W 6000K 580 Lm **cód. 146502**

A60 E27 LED

Ø:60 H:109 mm  220° | **PF >0.9**



Material PBT + Policarbonato
10W PF 0.5 3000K 880 Lm **cód. 144317**
10W PF 0.5 6000K 900 Lm **cód. 144318**
10W PF 0.9 6000K 900 Lm **cód. 147298**

Ø:60 H:120 mm  SENSOR |  200°



Material Plástico + Policarbonato
11W 6500K 1055 Lm **cód. 147511**
 **CON SENSOR DE MOVIMIENTO**

Ø:60 H:120 mm  DIM |  RGB |  200°



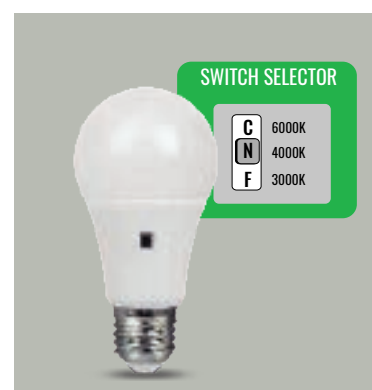

Material PBT + Policarbonato
10W 2700-6500K 806 Lm **cód. 146633**
 **RGB - 16 MILLONES DE COLORES**
 **FOCO SMART CON APP tuya®**

Ø:60 H:109 mm **3** CCT |  220°



Material Poliamida + Policarbonato
10W 3000-4000K-6500K 900 Lm **cód. 147827**
 **CON SWITCH SELECTOR DE LUZ CÁLIDA, NEUTRA O FRÍA**

GLOBOS E27 LED

Ø:95 H:127 mm  200°
 Ø:120 H:153 mm  200°



Material Policarbonato
12W 3000K 1100 Lm **cód. 133222**
12W 6000K 1200 Lm **cód. 133221**



C35 E14 LED

Ø:35 H:98 mm  300°



Material Vidrio
5W 2700K 540 Lm **cód. 146678**

G45 / G95 / G125 E27 LED

Ø:45 H:78 mm  300°
 Ø:95 H:140 mm  300°
 Ø:125 H:171 mm  300°



Material Vidrio
5W G45 2700K 540 Lm **cód. 146679**
7W G95 2700K 725 Lm **cód. 146682**
7W G125 2700K 725 Lm **cód. 146683**

ST64 E27 LED

Ø:64 H:140 mm  300°



Material Vidrio
7W 2700K 725 Lm **cód. 146681**

A60 E27 LED

Ø:60 H:108 mm  300°



Material Vidrio
7W 2700K 725 Lm **cód. 146680**

PRISMA E27 LED

Ø:110 H:140 mm  360°

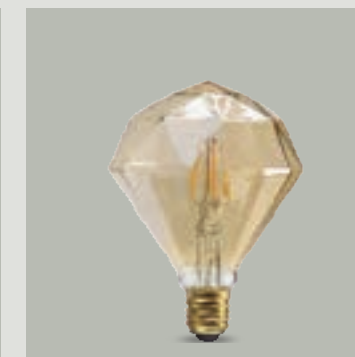

Material Vidrio
6W 2700K 600 Lm **cód. 147792**

UFOS E27 LED

Ø:143 H:76 mm
Ø:201 H:101 mm



PF
>0.9

Ø:292 H:120 mm
Ø:300 H:110 mm



Ø:185 H:90 mm



UFOS METÁLICOS E27 LED

Ø:185 H:95 mm



Ø:185 H:102 mm



Material PBT + Policarbonato

15W PF 0.5 3000K 1350 Lm **cód. 146007**
15W PF 0.5 6000K 1400 Lm **cód. 146008**
15W PF 0.9 6000K 1350 Lm **cód. 147828**
20W PF 0.5 3000K 1850 Lm **cód. 146009**
20W PF 0.5 6000K 1900 Lm **cód. 146010**

30W 6000K 2800 Lm **cód. 146012**
50W 6000K 4300 Lm **cód. 146444**

Material Policarbonato

24W 6500K 1920 Lm **cód. 145390**



Material Aluminio + Policarbonato

30W 6500K 2400 Lm **cód. 145399**



Material Aluminio + Policarbonato

30W 6500K 2500 Lm **cód. 147457**

CUBOS E27 LED

L:85 W:85 H:107 mm
L:95 W:95 H:122 mm



Material PBT

18W 3000K 1580 Lm **cód. 145621**
18W 6000K 1620 Lm **cód. 145622**
28W 6000K 2520 Lm **cód. 145623**

PAR38 E27 LED

Ø:121 H:121 mm



Material PBT + Policarbonato

15W 3000K 1200 Lm **cód. 143595**

Ø:121 H:121 mm



Material PBT + Policarbonato

15W 30K-40K-60K 1200 Lm **cód. 147912**

✓ CON SWITCH SELECTOR DE LUZ CALIDA, NEUTRA O FRIA

MINI HIGH POWER E27 LED

Ø:60 H:102 mm



Material Plástico + Policarbonato

20W 3000K 1600 Lm **cód. 147573**
20W 6500K 1600 Lm **cód. 147572**

Ø:70 H:106 mm

PF
>0.9



Material Plástico + Policarbonato

30W 6500K 2400 Lm **cód. 147574**



HIGH POWER E27 LED

Ø:80 H:155 mm
180°



Material Polipropileno
15W 6500K 1600 Lm **cód. 146232**

Ø:100 H:183 mm
180°



Material Polipropileno
26W 6500K 2560 Lm **cód. 145917**

Ø:120 H:205 mm
180°



Material Polipropileno
36W 6500K 3450 Lm **cód. 146260**

Ø:135 H:230 mm
180°



Material Polipropileno
45W 6500K 4300 Lm **cód. 145918**

Ø:150 H:255 mm
180°



Material Polipropileno
54W 6500K 5000 Lm **cód. 146725**

Tiras Flexibles LED

L:5000 H:100 mm | Rollo de 5 m
180°



✂
RECORTABLE
CADA 5 CM

Material Recubrimiento Siliconeado
50W (10W/m) 3000K 850 Lm/m **cód. 147122**
50W (10W/m) 4000K 800 Lm/m **cód. 147123**

- ✓ 60 CHIPS x METRO | NO INCLUYE DRIVER
- ✓ DRIVER 36W (IP20) 12V **cód. 147125**



L:5000 H:100 mm | Rollo de 5 m
180°

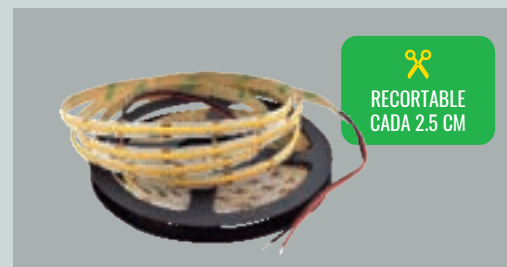

✂
RECORTABLE
CADA 2.5 CM

Material Recubrimiento Siliconeado
50W COB (10W/m) 3000K 931 Lm/m **cód. 147124**

- ✓ NO INCLUYE DRIVER
- ✓ DRIVER 72W (IP20) 12V **PFO.8** **cód. 147577**



L:5000 H:100 mm | Rollo de 5 m
L:10000 H:100 mm | Rollo de 10 m
180° IP65



✂
RECORTABLE
CADA 2.5 CM

Material Recubrimiento Siliconeado
50W COB (10W/m) 3000K 931 Lm/m **cód. 147378**
100W COB (10W/m) 3000K 931 Lm/m **cód. 147379**

- ✓ NO INCLUYE DRIVER
- ✓ DRIVER 80W (IP67) 12V **PFO.8** **cód. 147576**



Luminarias Suspendidas



Ø:600 mm | Altura regulable hasta 1200 mm

Material Aluminio + Acrílico

30W 3000K 1890 Lm ● cód. 146929

30W 3000K 1890 Lm ● cód. 146930

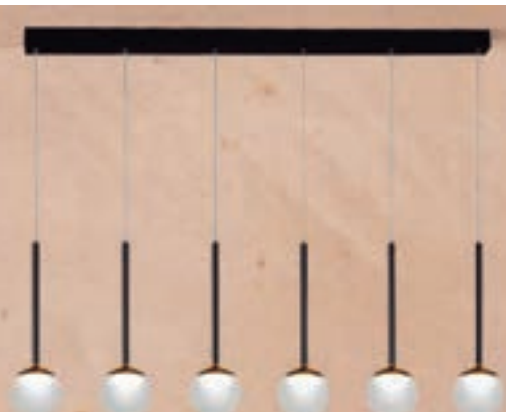

L:1100 mm | Altura regulable hasta 2100 mm

Material Aluminio + Metal + Acrílico

42W 3000K 2900 Lm cód. 146734



L:820 mm | Altura regulable hasta 1200 mm

Material Aluminio + Metal + Acrílico

24W 3000K 1920 Lm cód. 147522



Ø1:400 Ø2:600 Ø3:800 mm | Altura regulable hasta 1800 mm

Material Metal + Aluminio + Recubrimiento Siliconeado

114W 3000K 11183 Lm cód. 146629



L:1000 mm | Altura regulable hasta 1500 mm

Material Aluminio + Vidrio

60W 3000K 6000 Lm cód. 146152



L:665 mm | Altura regulable hasta 1200 mm

Material Metal + Acrílico

32W 3000K 2560 Lm ● cód. 147523

32W 3000K 2560 Lm ● cód. 147524



Ø:455 mm | Altura regulable hasta 1100 mm

Material ABS + Acrílico + Metal

36W 3000K 2520 Lm ● cód. 146954

36W 3000K 2520 Lm ● cód. 146952



Ø:273 mm | Altura regulable hasta 1200 mm

Material Aluminio + Silicona + Vidrio color ambar

12W + 1xG9 3000K 960 Lm cód. 147516

Máx.40W | Incluye estera de vidrio | No incluye foco



Ø:400 mm | Altura regulable hasta 1200 mm
 Material Aluminio + Silicona + Vidrio color ambar
 20W + 3xG9 3000K 1600 Lm **cód. 147517**
 Máx.40W | Incluye esferas de vidrio | No incluye focos



L:900 mm | Altura regulable hasta 900 mm
 Material Metal + Vidrio
 6xG9 MÁX 33W | No incluye focos **cód. 147103**



Ø:400 mm | Altura regulable hasta 1200 mm
 Material Aluminio
 1xE27 MÁX 60W | No incluye foco **cód. 146842**
 1xE27 MÁX 60W | No incluye foco **cód. 145902**



Ø:400 mm | Altura regulable hasta 1200 mm
 Material Aluminio
 1xE27 MÁX 60W | No incluye focos **cód. 146842**



L:374 mm | Altura regulable hasta 1220 mm
 Material Metal + Vidrio
 3xE27 MÁX 25W | No incluye focos **cód. 147476**



L:600 mm | Altura regulable hasta 1200 mm
 Material Metal
 3xE27 MÁX 40W | No incluye focos **cód. 146520**



Ø:300 mm H:250 mm | Altura regulable hasta 1200 mm
 Material Metal + Vidrio
 1xE27 MÁX 40W | No incluye foco **cód. 146522**

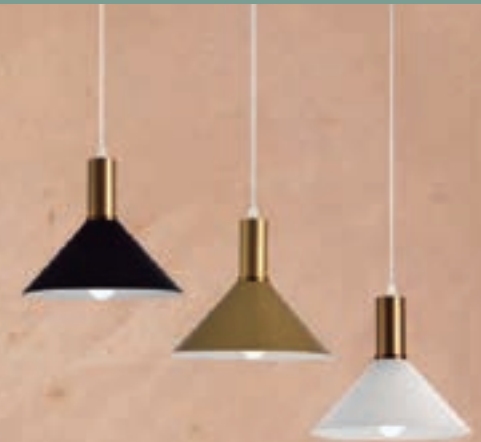

Ø:250 H:250 mm | Altura regulable hasta 1200 mm
 Material Aluminio + Metal
 1xE27 MÁX 40W | No incluye foco **cód. 146513**
 1xE27 MÁX 40W | No incluye foco **cód. 146512**
 1xE27 MÁX 40W | No incluye foco **cód. 146511**



Ø:380 mm | Altura regulable hasta 1270 mm
Material Metal + Bambú
1xE27 MÁX 40W | No incluye foco **cód. 147470**



Ø:300 mm | Altura regulable hasta 1300 mm
Material Metal + Bambú
1xE27 MÁX 40W | No incluye foco **cód. 147469**



Ø:230 mm | Altura regulable hasta 1360 mm
Material Metal + Bambú
1xE27 MÁX 40W | No incluye foco **cód. 147471**



L:600 mm | Altura regulable hasta 1300 mm
Material Metal + Bambú
1xE27 MÁX 40W | No incluye foco **cód. 147472**

Luminarias de Doble Altura



Ø:460 mm | Altura regulable hasta 2100 mm
Material Aluminio + Metal + Acrílico
42W 3000K 2900 Lm **cód. 146735**



Ø:850 mm | Altura regulable hasta 2100 mm
Material Aluminio + Vidrio soplado
18xE14 MÁX 40W | No incluye focos **cód. 146863**

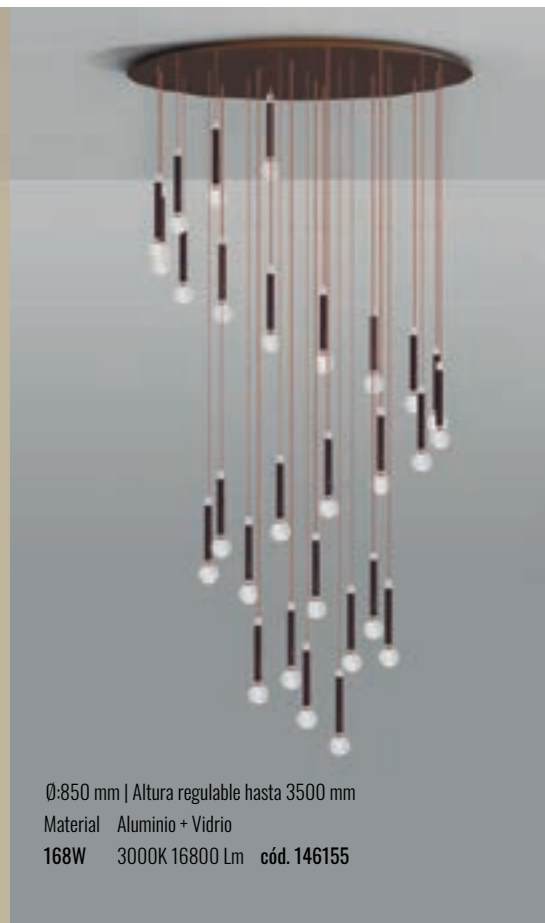

Ø:850 mm | Altura regulable hasta 3500 mm
Material Aluminio + Vidrio
168W 3000K 16800 Lm **cód. 146155**



Ø:400 mm | Altura regulable hasta 2100 mm
Material Metal + Vidrio
10xE27 MÁX 40W | No incluye focos **cód. 147102**

Luminarias de Acento



Ø:160 mm | Altura regulable hasta 1200 mm
 Material Aluminio + Metal + Acrílico
 8W 3000K 640 Lm ● **cód. 147520**
 8W 3000K 640 Lm ● **cód. 147521**

PF >0.9 | **50 MIL HORAS**



Ø:80 H:190 mm | Altura regulable hasta 1000 mm
 Material Aluminio + Policarbonato
 25W 3000K 2000 Lm **cód. 145288**



L:200 H:200 mm | Altura regulable hasta 1500 mm
 Material Metal con detalle en espejo + Acrílico
 18W 3000K 420 Lm ● **cód. 147134**
 18W 3000K 420 Lm ● **cód. 146969**

LUZ DIRECTA E INDIRECTA



Ø:41 H:330 mm | Altura regulable hasta 1200 mm
 Material Aluminio + Acrílico
 7W 3000K 420 Lm ○ **cód. 145656**
 7W 3000K 420 Lm ● **cód. 145655**
 7W 3000K 420 Lm ● **cód. 145657**



Ø:80 H:380 mm | Altura regulable hasta 1200 mm
 Material Aluminio + Vidrio
 6W 3000K 600 Lm **cód. 146620**



Ø:55 L:400 mm | Altura regulable hasta 1500 mm
 Material Aluminio + Vidrio
 5W 3000K 500 Lm **cód. 146158**



Ø:201 mm | Altura regulable hasta 1270 mm
 Material Metal
 1xE27 MÁX 25W | No incluye foco **cód. 147474**



Ø:60 H:300 mm | Altura regulable hasta 1520 mm
 Material Aluminio
 1xGU10 MÁX 40W | No incluye foco ○ **cód. 147162**
 1xGU10 MÁX 40W | No incluye foco ● **cód. 147163**
 1xGU10 MÁX 40W | No incluye foco ● **cód. 147164**

Protección contra ingresos de polvo y agua

IP65



CONTRA INGRESO DE POLVO

0		Ninguna protección
1		Protegido frente a objetos sólidos ≥ 50 mm
2		Protegido frente a objetos sólidos ≥ 12.5 mm
3		Protegido frente a objetos sólidos ≥ 2.5 mm
4		Protegido frente a objetos sólidos ≥ 1 mm
5		Protegido frente a la suciedad
6		Hermético. Total protección frente a la suciedad

CONTRA INGRESO DE AGUA

0		Ninguna protección
1		Protegido frente a goteos verticales
2		Protegido frente a goteos que caen verticales $<15^\circ$
3		Protegido frente a agua pulverizada
4		Protegido frente a salpicaduras
5		Protegido frente a chorros de agua a presión
6		Protegido frente a fuertes chorros de agua a presión
7		Protegido frente a inmersiones de 1 m de profundidad durante 30 min
8		Protegido frente a inmersiones de alta presión y temperatura

Conoce nuestra línea de
Iluminación Arquitectónica

ARKOSLIGHT
HECHO EN ESPAÑA



CONOCE MÁS SOBRE
NUESTROS PRODUCTOS



LIGHTTECH

- » TECNOLOGÍA LED
- » VARIEDAD Y AMPLIO STOCK

Lumi
CENTER

- » DESARROLLO DE PROYECTOS
- » ASESORÍA ESPECIALIZADA

- 📍 Av. Felipe Pardo y Aliaga 422,
San Isidro. Lima - Perú
- ☎ 981 333 072
- ✉ ventas@lumicenter.com.pe
- 🌐 lumicenter.com.pe
- 📘 LumicenterPeru
- 📷 LumicenterPeru