

2023



PLAFONES LED

📍 Av. Felipe Pardo y Aliaga 422,
San Isidro. Lima - Perú

☎ (51) 441 9552 📞 981 333 072

✉ ventas@lumicenter.com.pe

📘 LumicenterPeru 📷 LumicenterPeru

🌐 lumicenter.com.pe





PLAFONES LED DUO

Potencia: 37W
 Temperatura de Color: 3000K
 Lúmenes: 2590 Lm
 Material cuerpo: Metal
 Material pantalla: Policarbonato
 SKU: ● 147341 (Dorado/Blanco)
 ● 147342 (Dorado/Marrón)

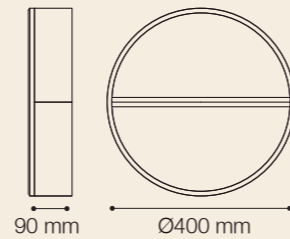

ILUMINACIÓN
 EN PANTALLA
 Y EN BORDE



PLAFÓN LED DUO CUADRADO

Potencia: 63W
 Temperatura de Color: 4000K
 Lúmenes: 4410 Lm
 Material cuerpo: Metal
 Material pantalla: Policarbonato
 SKU: ● 147343 (Negro/Blanco)

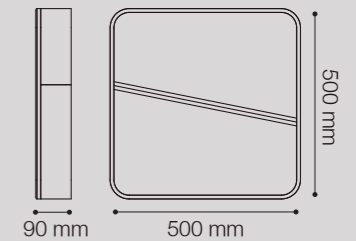

ILUMINACIÓN
 EN PANTALLA
 Y EN BORDE



PLAFÓN LED BALI

Potencia: 45W
 Temperatura de Color: 3000K
 Lúmenes: 2279 Lm
 Material cuerpo: Aluminio + Metal
 Material esfera: Acrílico
 SKU: ● 146729 (Marrón)

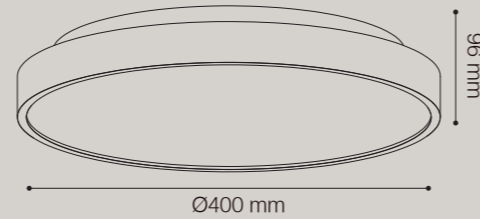

PLAFÓN LED NINFA

Potencia: 50W
 Temperatura de Color: 3000K
 Lúmenes: 3750 Lm
 Material cuerpo: Acrílico + ABS
 Material pantalla: Acrílico
 SKU: ● 146951 (Blanco/Tipo Madera)

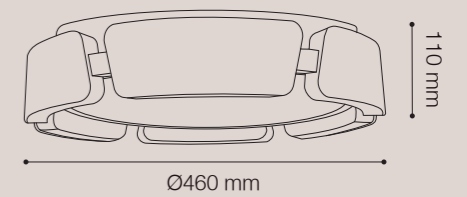

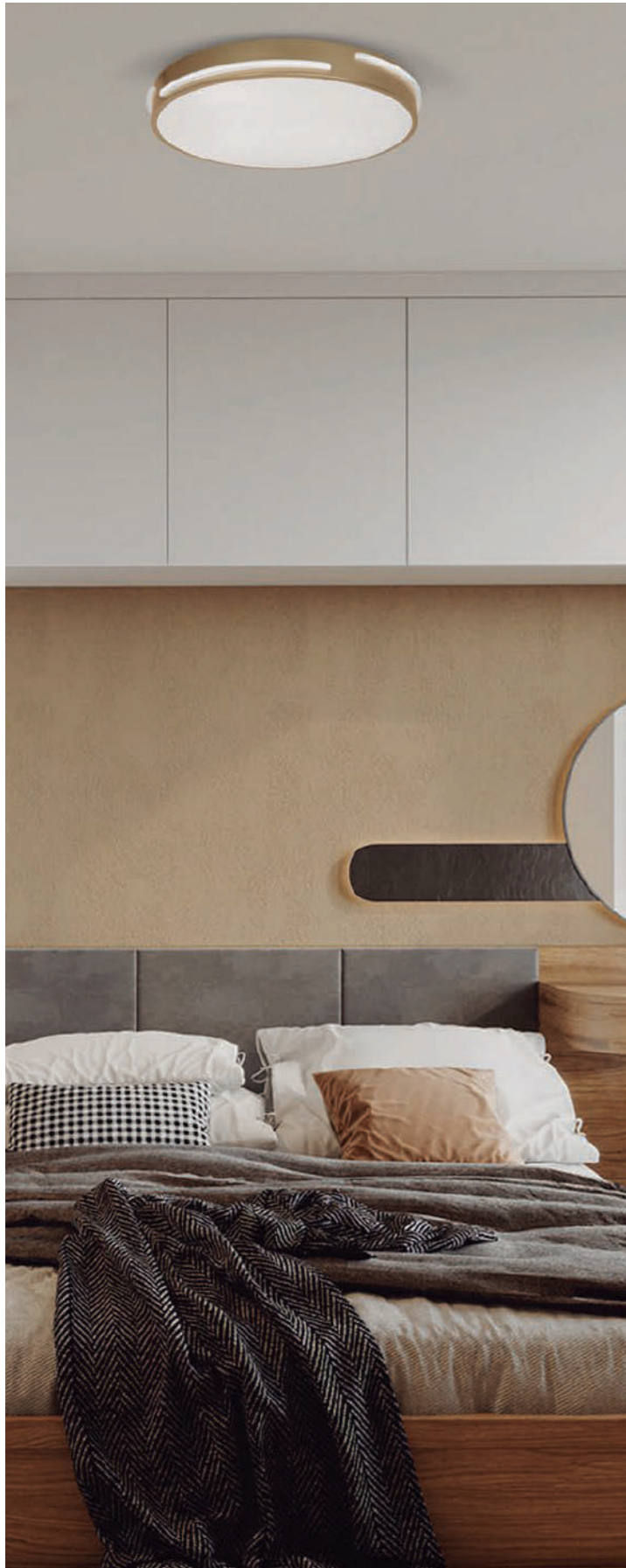

PLAFÓN LED NIMBO

Potencia: 36W
 Temperatura de Color: 3000K
 Lúmenes: 2160 Lm
 Material cuerpo: Metal + Aluminio
 Material pantalla: Acrílico
 SKU: ● 147083 (Dorado)

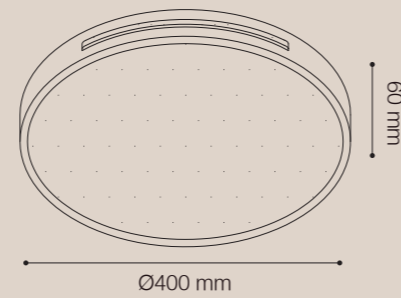

PLAFÓN LED HILA

Potencia: 45W
 Temperatura de Color: 3000K
 Lúmenes: 3375 Lm
 Material cuerpo: Aluminio + Metal
 Material pantalla: Acrílico
 SKU: ● 146731 (Dorado)

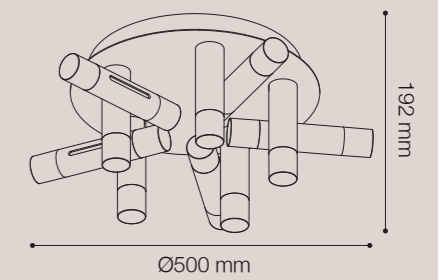

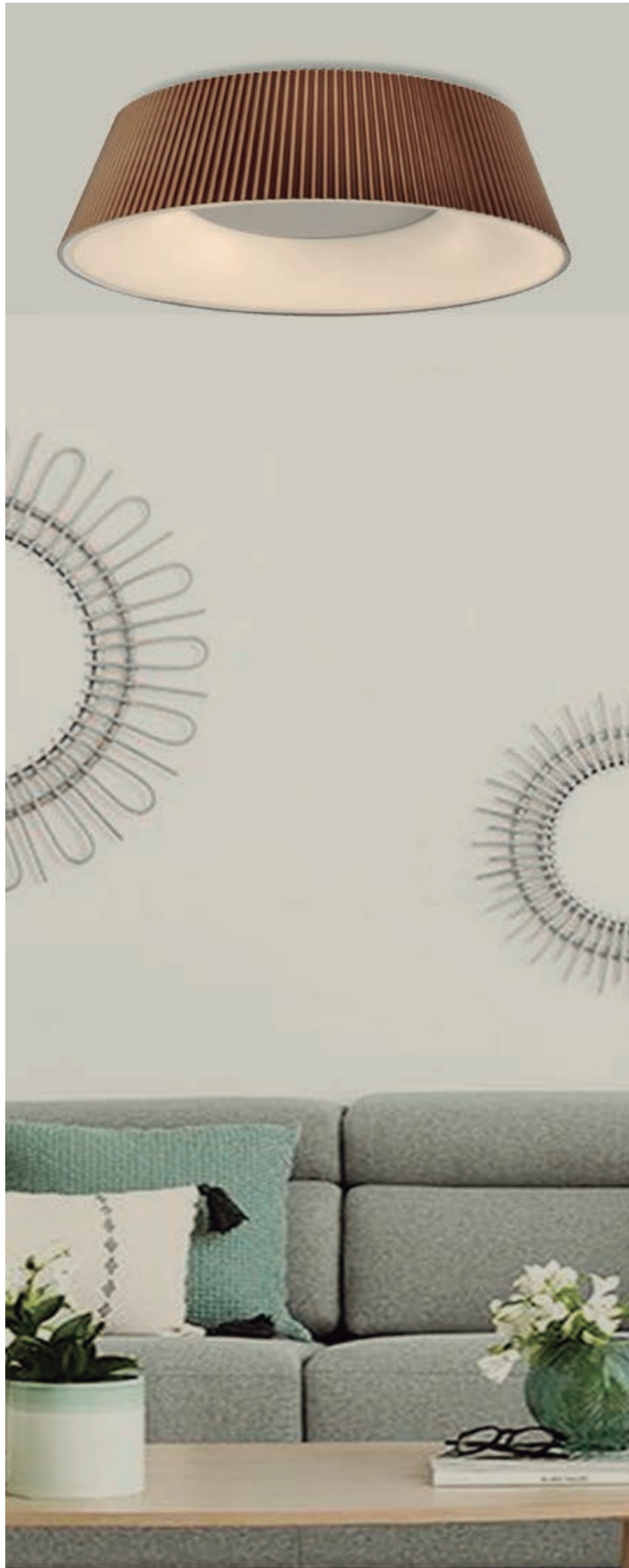

PLAFONES LED PIROTT

Potencia: 32W
 Temperatura de Color: 3000K
 Lúmenes: 2720 Lm
 Material cuerpo: Metal + ABS
 Material pantalla: Acrílico
 SKU: ● 146383 (Blanco)
 ● 146384 (Marrón)

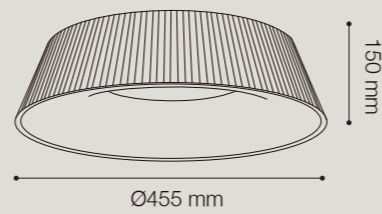

PLAFONES LED PIROTT WOOD

Potencia: 36W
 Temperatura de Color: 3000K
 Lúmenes: 2520 Lm
 Material cuerpo: Metal + ABS
 Material pantalla: Acrílico
 SKU: ● 146953 (Blanco/Tipo Madera)
 ● 146955 (Negro/Tipo Madera)

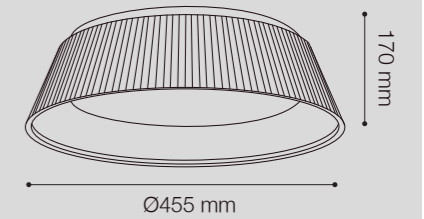



PLAFONES LED RASO

Potencia: 40W
 Temperaturas de Color: 3000K / 6000K
 Lúmenes: 2800 Lm
 Material cuerpo: Plástico
 Material pantalla: PMMA

Índice de Protección: IP40

- SKU: ● 147080 (Oro Rosa 3000K)
 ● 147079 (Oro Rosa 6000K)
 ● 147082 (Marrón 3000K)
 ● 147081 (Marrón 6000K)

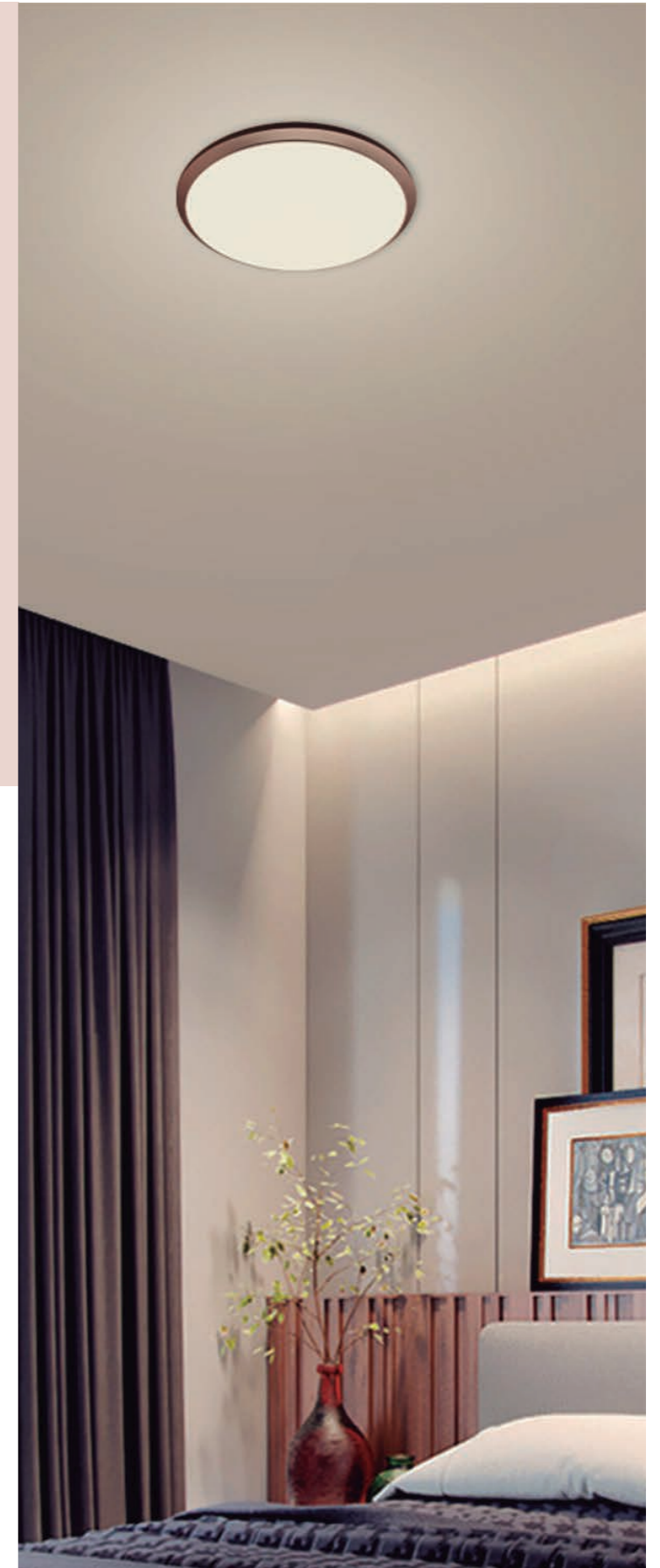
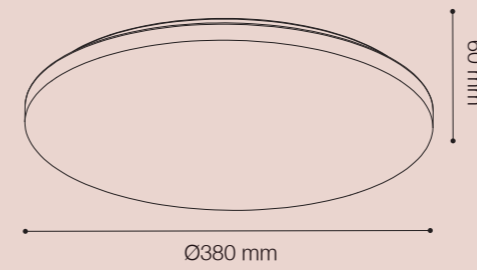



PLAFONES LED SHINY

Potencia: 40W
 Temperaturas de Color: 3000K / 6000K
 Lúmenes: 2800 Lm
 Material cuerpo: Plástico
 Material pantalla: PMMA
Índice de Protección: IP40
 SKU: ● 147076 (Blanco 3000K)
 ● 147075 (Blanco 6000K)

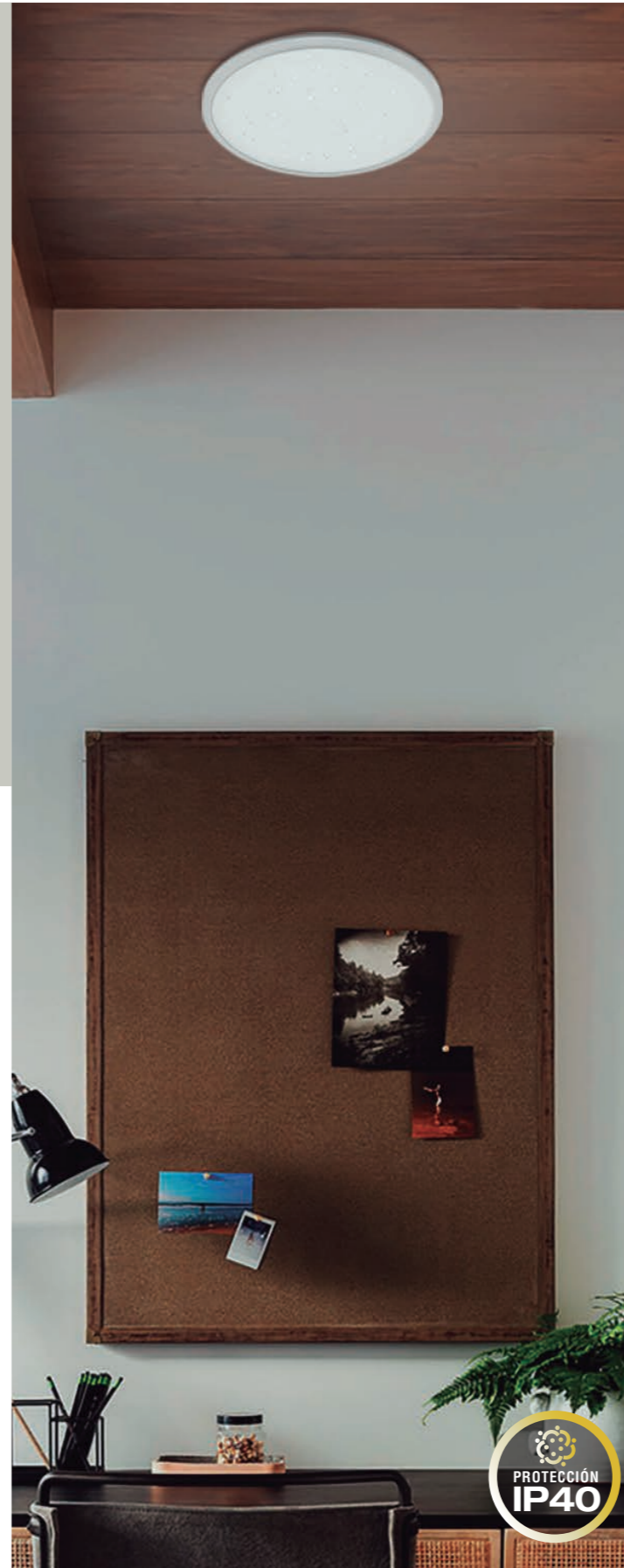
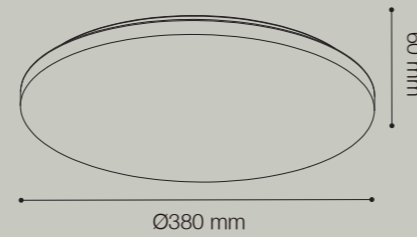

PLAFONES LED RASO SHINY

Potencia: 40W
 Temperaturas de Color: 3000K / 6000K
 Lúmenes: 2800 Lm
 Material cuerpo: Plástico
 Material pantalla: PMMA
Índice de Protección: IP40
 SKU: ● 147078 (Blanco 3000K)
 ● 147077 (Blanco 6000K)

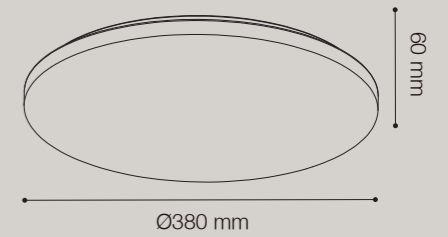

PLAFÓN SMART LED RGB / PARLANTE

Potencia: 48W
 Temperatura de Color: 3000K / 4000K / 6000K
 Lúmenes: 1440 Lm / 2880 Lm
 Material cuerpo: Prolipropileno + Policloruro
 Material esferas: Prolipropileno
 SKU: ● 147087 (Silver/Blanco)

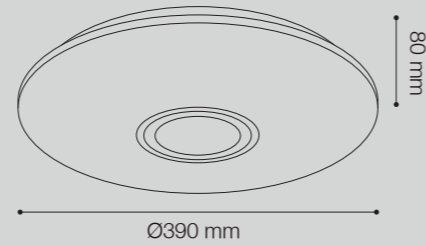

PLAFÓN LED PRO

Potencia: 18W
 Temperaturas de Color: 3000K / 4000K / 6000K
 Lúmenes: 2700 Lm
 Material cuerpo: Policarbonato
 Material pantalla: Policarbonato
Índice de Protección: IP65
Factor de Potencia: 0.9
Vida útil: 50,000 horas
 SKU: ● 146726 (Blanco)

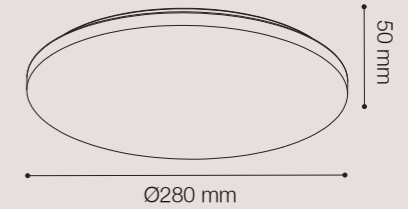

ELECCIÓN
DE TIPO DE LUZ

- LUZ CÁLIDA
- LUZ DÍA
- LUZ FRÍA



SWITCH INTERNO
PARA SELECCIÓN DE
TEMPERATURA DE COLOR

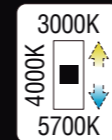

PLAFONES LED

Potencia: 30W
 Temperaturas de Color: 3000K / 6000K
 Lúmenes: 2350 Lm / 2500 Lm / 2650 Lm / 2700 Lm
 Material cuerpo: Policarbonato
 Material pantalla: Policarbonato

Índice de Protección: IP65

- SKU: ● 144696 (Silver 3000K)
 ● 144697 (Silver 6000K)
 ● 145652 (Dorado 3000K)
 ● 145651 (Dorado 6000K)

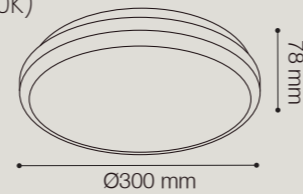

PLAFÓN LED 3 TIPOS DE LUZ EN 1

Potencia: 30W
 Temperaturas de Color: 3000K - 6000K - 4000K
 Lúmenes: 2750 Lm
 Material cuerpo: Policarbonato
 Material pantalla: Policarbonato

Índice de Protección: IP65

- SKU: ● 145702 (Silver)

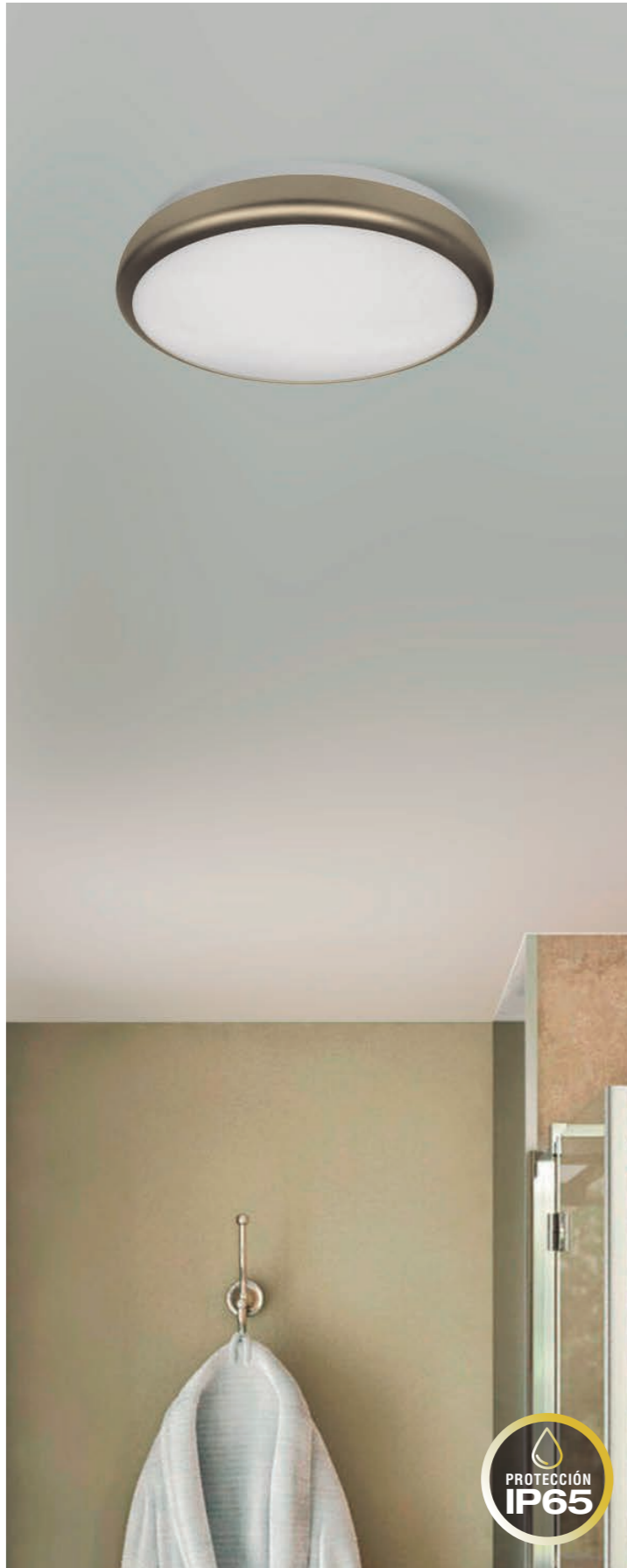
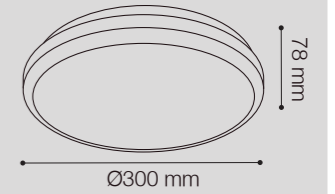

SWITCH PARA SELECCIÓN DE COLOR DE LUZ (ON/OFF)

- | | | |
|---|---------------------------------------|---------------------------------------|
| PASO
1
Luz Amarilla | PASO
2
Luz Blanca | PASO
3
Luz Neutra |
|---|---------------------------------------|---------------------------------------|

PLAFONES HERMÉTICOS LED

Potencia: 15W
 Temperaturas de Color: 3000K / 6000K
 Lúmenes: 1400 Lm / 1480 Lm
 Material cuerpo: Aluminio + Policarbonato
 Material pantalla: Policarbonato
Índice de Protección: IP65
 SKU: ● 143666 (Blanco 3000K)
 ● 143551 (Blanco 6000K)

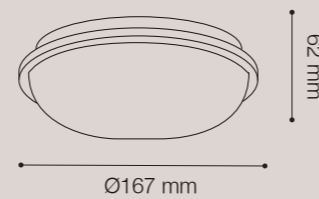

Potencia: 20W
 Temperaturas de Color: 3000K / 6000K
 Lúmenes: 1750 Lm / 1800 Lm
 Material cuerpo: Aluminio + Policarbonato
 Material pantalla: Policarbonato
Índice de Protección: IP65
 SKU: ● 144623 (Blanco 3000K)
 ● 144622 (Blanco 6000K)

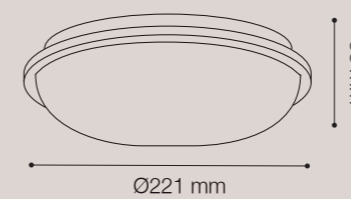

Potencia: 20W
 Temperaturas de Color: 3000K / 6000K
 Lúmenes: 1750 Lm / 1800 Lm
 Material cuerpo: Aluminio + Policarbonato
 Material pantalla: Policarbonato
Índice de Protección: IP65
 SKU: ● 145647 (Gris 3000K)
 ● 145417 (Gris 6000K)
 ● 145649 (Dorado 6000K)
 ● 145648 (Dorado 6000K)
 ● 145650 (Negro 6000K)

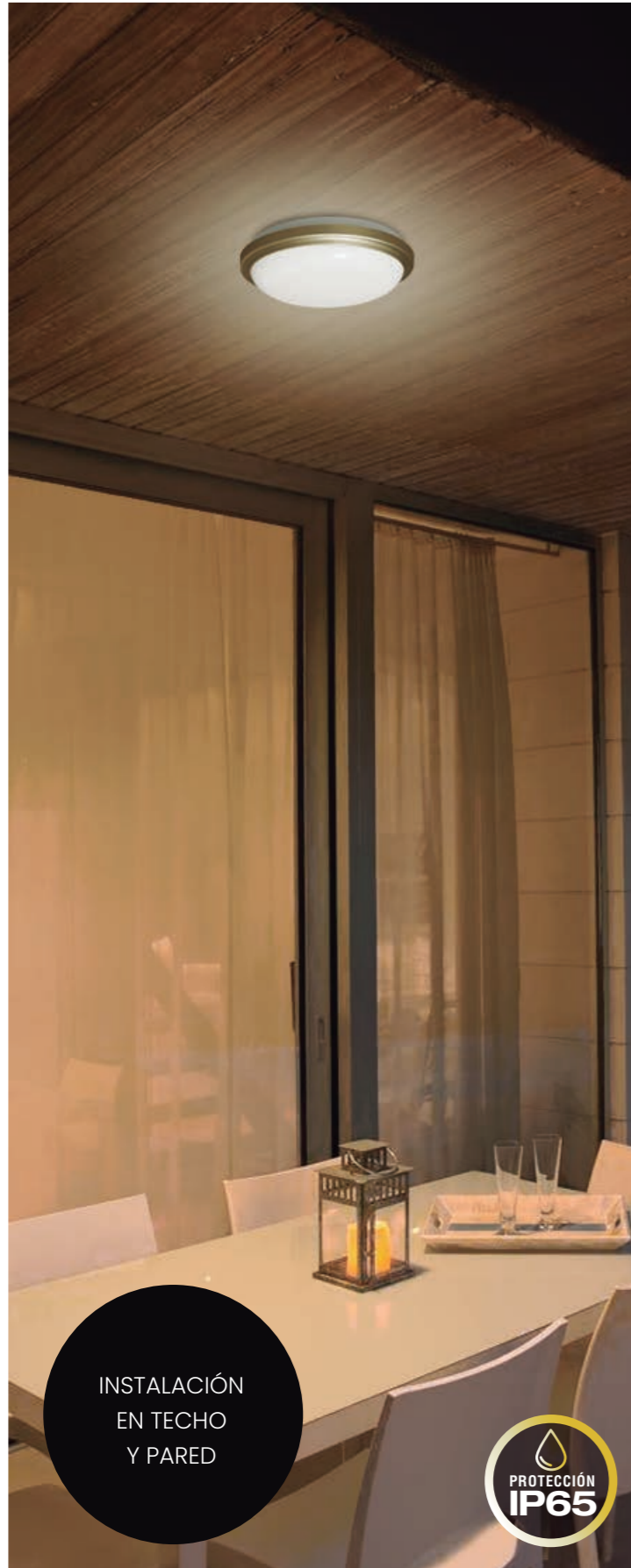
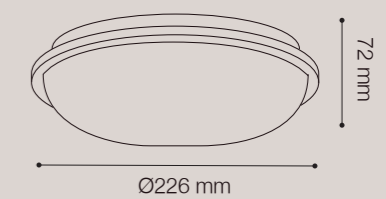

PLAFÓN EXTERIOR LED CON SENSOR DE MOVIMIENTO

Potencia: 20W
 Temperatura de color: 6000K
 Lúmenes: 1800Lm
 Material cuerpo: Aluminio + Policarbonato
 Material pantalla: Policarbonato
Índice de Protección: IP65
 SKU: ● 145367 (Blanco)

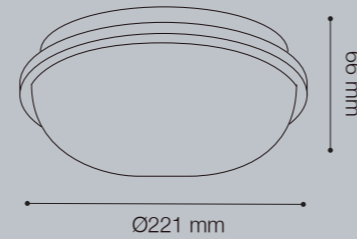

La luz se encenderá cuando haya movimiento dentro del área de detección.

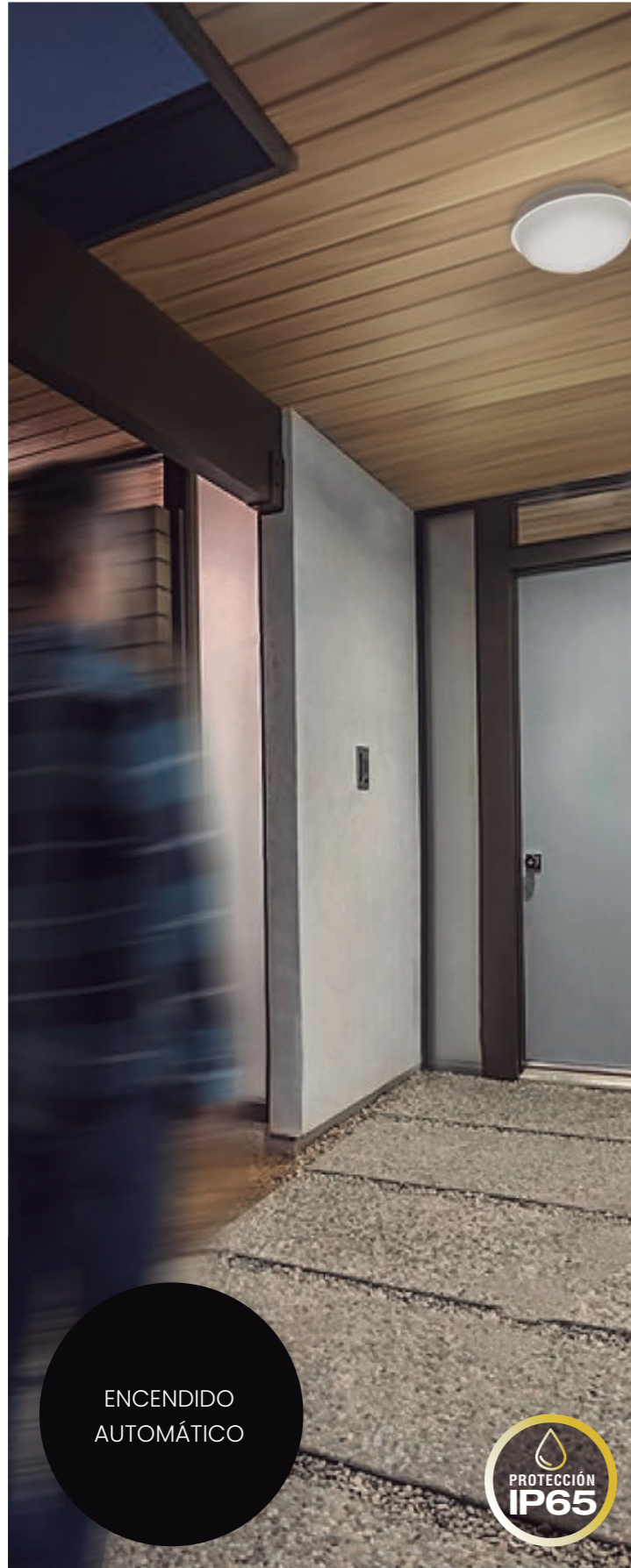

ENCENDIDO
AUTOMÁTICO



ÁREA DE DETECCIÓN
DE 4 A 6 METROS



ÍNDICE DE PROTECCIÓN
IP65



APAGADO AUTOMÁTICO
EN 15" AL NO DETECTAR
MOVIMIENTO



PLAFONES LED HIELO

Potencia: 12W
 Temperaturas de Color: 3000K / 6000K
 Lúmenes: 1030 Lm / 1080 Lm
 Material cuerpo: METAL + ABS
 Material pantalla: ABS
 SKU: ● 145587 (Blanco 3000K)
 ● 145588 (Blanco 6000K)

Potencia: 24W
 Temperatura de Color: 6000K
 Lúmenes: 2160 Lm
 Material cuerpo: METAL + ABS
 Material pantalla: ABS
 SKU: ● 145589 (Blanco 6000K)

Potencia: 36W
 Temperaturas de Color: 3000K / 6000K
 Lúmenes: 3160 Lm / 3240 Lm
 Material cuerpo: METAL + ABS
 Material pantalla: ABS
 SKU: ● 145818 (Blanco 3000K)
 ● 145590 (Blanco 6000K)

Potencia: 48W
 Temperatura de Color: 6000K
 Lúmenes: 4320 Lm
 Material cuerpo: METAL + ABS
 Material pantalla: ABS
 SKU: ● 145591 (Blanco 6000K)

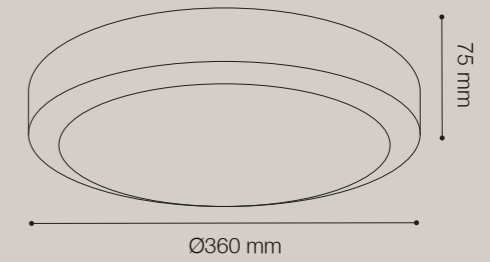
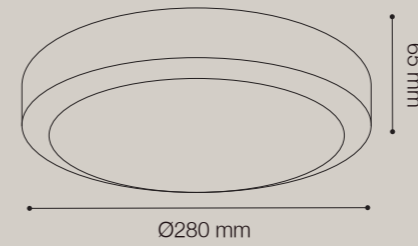
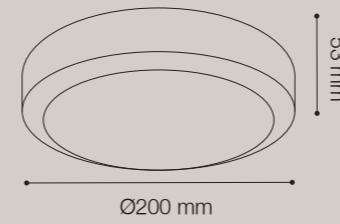
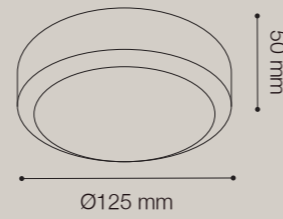



LUMINARIAS LED FRAMELESS

Potencia: 17W
 Temperaturas de Color:
 3000K / 6500K
 Lúmenes: 1700 Lm
 Material cuerpo: Policarbonato
 Material pantalla: Policarbonato
 SKU: ● 146958 (Blanco 3000K)
 ● 146976 (Blanco 6500K)

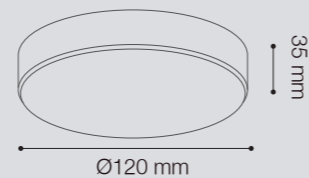

Potencia: 24W
 Temperaturas de Color:
 3000K / 4000K / 6500K
 Lúmenes: 2400 Lm
 Material cuerpo: Policarbonato
 Material pantalla: Policarbonato
 SKU: ● 146944 (Blanco 3000K)
 ● 146945 (Blanco 4000K)
 ● 146946 (Blanco 6500K)

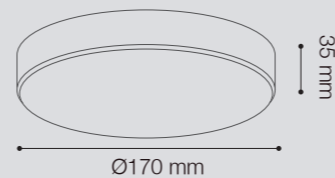

Potencia: 32W
 Temperaturas de Color:
 3000K / 6500K
 Lúmenes: 2880 Lm / 3200 Lm
 Material cuerpo: Policarbonato
 Material pantalla: Policarbonato
 SKU: ● 146440 (Blanco 3000K)
 ● 147112 (Blanco 6500K)



Potencia: 24W
 Temperaturas de Color:
 3000K / 6500K
 Lúmenes: 2160 Lm
 Material cuerpo: Policarbonato
 Material pantalla: Policarbonato
 SKU: ● 146442 (Blanco 3000K)
 ● 146443 (Blanco 6500K)

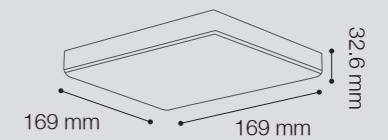

2 TIPOS DE INSTALACIÓN

✓ Adosado con Cruceta



✓ En foro con Clips





ARTEFACTO LED CON DIFUSOR

Potencia: 40W
 Temperatura de Color: 4000K
 Lúmenes: 4000 Lm
 Material cuerpo: Aluminio
 Material difusor: Acrílico
 SKU: ● 145302 (Silver)

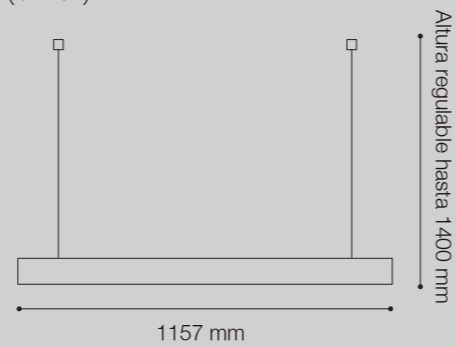

ARTEFACTO LED CON DIFUSOR

Potencia: 40W
 Temperatura de Color: 4000K
 Lúmenes: 4000 Lm
 Material cuerpo: Aluminio
 Material difusor: Acrílico
 SKU: ● 145705 (Negro)

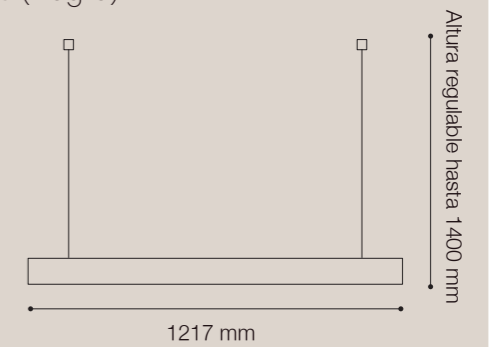

ADOSADO O SUSPENDIDO

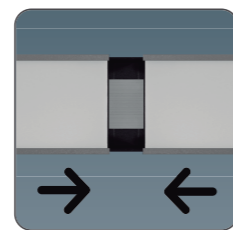
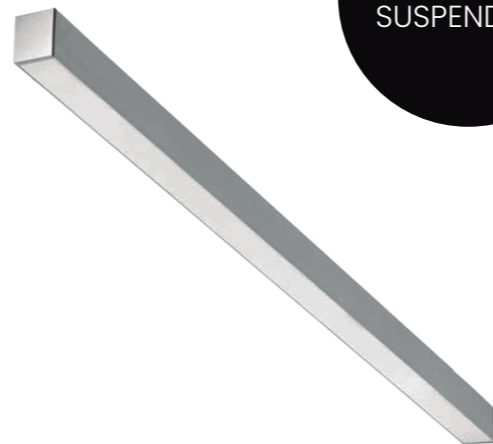

Opción para unir en línea con conector invisible

ADOSADO O SUSPENDIDO

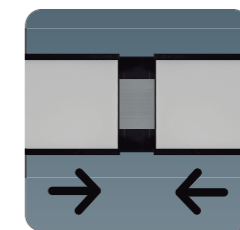

Opción para unir en línea con conector invisible

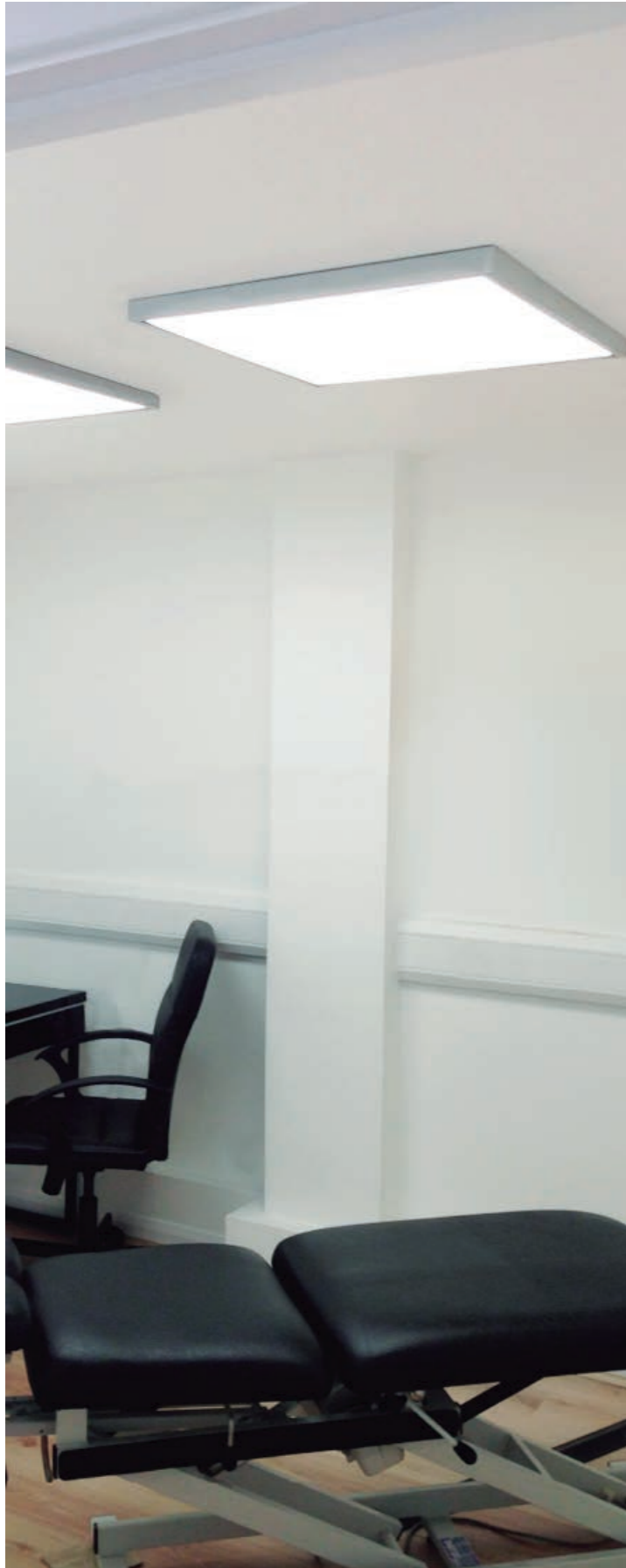

PANELES ADOSADOS LED

Potencia: 48W
Temperatura de Color: 6000K
Lúmenes: 4320Lm
Material cuerpo: Aluminio + Acero
Material difusor: Polipropileno
Driver: Externo
SKU: ● 146391 (Blanco)

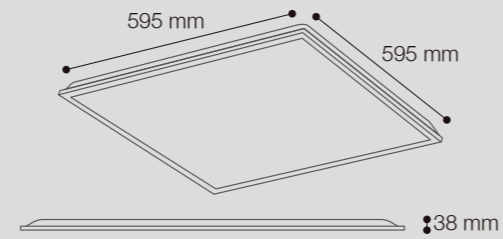

Potencia: 48W
Temperatura de Color: 6000K
Lúmenes: 3840Lm
Material cuerpo: Aluminio
Material difusor: Polipropileno
Driver: Externo
SKU: ● 146235 (Blanco)

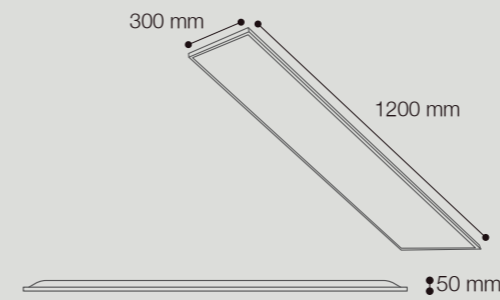

Potencia: 40W
Temperatura de Color: 6000K
Lúmenes: 4000Lm
Material cuerpo: Aluminio
Material difusor: Policarbonato
Driver: Externo
SKU: ● 146496 (Blanco)

